

**TOSHIBA Satellite U300 /
Satellite Pro U300 / PORTEGE
M600 / TECRA M8 Series
User's Manual**

Copyright

© 2007 by TOSHIBA Corporation. All rights reserved. Under the copyright laws, this manual cannot be reproduced in any form without the prior written permission of TOSHIBA. No patent liability is assumed, with respect to the use of the information contained herein.

TOSHIBA Satellite U300 / Satellite Pro U300 / PORTEGE M600 / TECRA M8 Series Portable Personal Computer User's Manual

First edition June 2007

Ownership and copyright of music, video, computer programs, databases, etc. are protected by the copyright laws. These copyrighted materials may be copied for private use at home only. If, beyond the limitation above, you copy (including to transform data formats) or modify these materials, transfer them or distribute them via the Internet without approval of copyright owners, you may be subject to claims for compensation for damage and/or criminal penalties due to infringements of copyrights or personal rights. Please remember to observe the copyright laws when you use this product to copy the copyrighted works or perform other actions.

Please note that you may infringe the owner's rights protected by the copyright laws if you use the screen mode switching functions (e.g. Wide mode, Wide Zoom mode, etc.) of this product to display enlarged images/video at coffee shops or hotels for the purposes of profits or providing these to the public.



This product incorporates copyright protection technology that is protected by U.S. patents and other intellectual property rights. Use of this copyright protection technology must be authorized by Macrovision, and is intended for home and other limited viewing uses only unless otherwise authorized by Macrovision. Reverse engineering or disassembly is prohibited.

Disclaimer

This manual has been validated and reviewed for accuracy. The instructions and descriptions it contains are accurate for the TOSHIBA Satellite U300 / Satellite Pro U300 / PORTEGE M600 / TECRA M8 Series Portable Personal Computer at the time of this manual's production. However, succeeding computers and manuals are subject to change without notice. TOSHIBA assumes no liability for damages incurred directly or indirectly from errors, omissions or discrepancies between the computer and the manual.

Trademarks

Intel, Centrino, Intel Core and Celeron are trademarks or registered trademarks of Intel Corporation or its subsidiaries in the United States and other countries.

Windows® and Microsoft are registered trademark of Microsoft Corporation.

Photo CD is a trademark of Eastman Kodak.

Other trademarks and registered trademarks not listed above may be used in this manual.

FCC information

FCC notice “Declaration of Conformity Information”

This equipment has been tested and found to comply with the limits for a Class B digital device, pursuant to part 15 of the FCC rules. These limits are designed to provide reasonable protection against harmful interference in a residential installation. This equipment generates, uses and can radiate radio frequency energy and, if not installed and used in accordance with the instructions, may cause harmful interference to radio communications. However, there is no guarantee that interference will not occur in a particular installation. If this equipment does cause harmful interference to radio or television reception, which can be determined by turning the equipment off and on, the user is encouraged to try to correct the interference by one or more of the following measures:

- Reorient or relocate the receiving antenna.
- Increase the separation between the equipment and receiver.
- Connect the equipment into an outlet on a circuit different from that to which the receiver is connected.
- Consult the dealer or an experienced radio/TV technician for help.



Only peripherals complying with the FCC class B limits may be attached to this equipment. Operation with non-compliant peripherals or peripherals not recommended by TOSHIBA is likely to result in interference to radio and TV reception. Shielded cables must be used between the external devices and the computer's external monitor port, USB port, serial port, parallel port, PS/2 mouse/keyboard port and microphone jack. Changes or modifications made to this equipment, not expressly approved by TOSHIBA or parties authorized by TOSHIBA could void the user's authority to operate the equipment.

FCC conditions

This device complies with part 15 of the FCC Rules. Operation is subject to the following two conditions:

1. This device may not cause harmful interference.
2. This device must accept any interference received, including interference that may cause undesired operation.

Contact

Address: TOSHIBA America Information Systems, Inc.
9740 Irvine Boulevard
Irvine, California 92618-1697

Telephone: (949) 583-3000

EU Declaration of Conformity



TOSHIBA declares that this product conforms to the following Standards:
Supplementary Information: “The product complies with the requirements of the Low Voltage Directive 73/23/EEC, the EMC Directive 89/336/EEC and/or the R&TTE Directive 1999/5/EC.”

This product is carrying the CE-Mark in accordance with the related European Directives. Responsible for CE-Marking is TOSHIBA Europe, Hammfelddamm 8, 41460 Neuss, Germany.

VCCI Class B Information

この装置は、情報処理装置等電波障害自主規制協議会（VCCI）の基準に基づくクラスB情報技術装置です。この装置は、家庭環境で使用することを目的としていますが、この装置がラジオやテレビジョン受信機に近接して使用されると、受信障害を引き起こすことがあります。
取扱説明書に従って正しい取り扱いをして下さい。

Canadian Regulatory Information (Canada Only)

This digital apparatus does not exceed the Class B limits for radio noise emissions from digital apparatus as set out in the Radio Interference Regulation of the Canadian Department of Communications.

Note that Canadian Department of Communications (DOC) regulations provide, that changes or modifications not expressly approved by TOSHIBA Corporation could void your authority to operate this equipment.

This Class B digital apparatus meets all requirements of the Canadian Interference-Causing Equipment Regulations.

Cet appareil numérique de la class B respecte toutes les exigences du Règlement sur le matériel brouilleur du Canada.

Modem warning notice

Conformity Statement

The equipment has been approved to [Council Decision 98/482/EC - "TBR 21"] for pan-European single terminal connection to the Public Switched Telephone Network (PSTN).

However, due to differences between the individual PSTNs provided in different countries/regions the approval does not, of itself, give an unconditional assurance of successful operation on every PSTN network termination point.

In the event of problems, you should contact your equipment supplier in the first instance.

Network Compatibility Statement

This product is designed to work with, and is compatible with the following networks. It has been tested to and found to conform with the additional requirements conditional in EG 201 121.

Germany	ATAAB AN005, AN006, AN007, AN009, AN010 and DE03, 04, 05, 08, 09,12,14,17
Greece	ATAAB AN005, AN006 and GR01, 02, 03, 04
Portugal	ATAAB AN001, 005, 006, 007, 011 and P03, 04, 08, 10

Spain	ATAAB AN005, 007, 012, and ES01
Switzerland	ATAAB AN002
All other countries/ regions	ATAAB AN003, 004

Specific switch settings or software setup are required for each network, please refer to the relevant sections of the user guide for more details.

The hookflash (timed break register recall) function is subject to separate national type approvals. It has not been tested for conformity to national type regulations, and no guarantee of successful operation of that specific function on specific national networks can be given.

Pursuant to FCC CFR 47, Part 68:

When you are ready to install or use the modem, call your local telephone company and give them the following information:

- The telephone number of the line to which you will connect the modem.
- The registration number that is located on the device. The FCC registration number of the modem will be found on either the device which is to be installed, or, if already installed, on the bottom of the computer outside of the main system label.
- The Ringer Equivalence Number (REN) of the modem, which can vary. For the REN of your modem, refer to your modem's label.

The modem connects to the telephone line by means of a standard jack called the USOC RJ11C.

Type of service

Your modem is designed to be used on standard-device telephone lines. Connection to telephone company-provided coin service (central office implemented systems) is prohibited. Connection to party lines service is subject to state tariffs.

If you have any questions about your telephone line, such as how many pieces of equipment you can connect to it, the telephone company will provide this information upon request.

Telephone company procedures

The goal of the telephone company is to provide you with the best service it can. In order to do this, it may occasionally be necessary for them to make changes in their equipment, operations, or procedures. If these changes might affect your service or the operation of your equipment, the telephone company will give you notice in writing to allow you to make any changes necessary to maintain uninterrupted service.

If problems arise

If any of your telephone equipment is not operating properly, you should immediately remove it from your telephone line, as it may cause harm to the telephone network. If the telephone company notes a problem, they may temporarily discontinue service. When practical, they will notify you in advance of this disconnection. If advance notice is not feasible, you will be notified as soon as possible. When you are notified, you will be given the opportunity to correct the problem and informed of your right to file a complaint with the FCC. In the event repairs are ever needed on your modem, they should be performed by TOSHIBA Corporation or an authorized representative of TOSHIBA Corporation.

Disconnection

If you should ever decide to permanently disconnect your modem from its present line, please call the telephone company and let them know of this change.

Fax branding

The Telephone Consumer Protection Act of 1991 makes it unlawful for any person to use a computer or other electronic device to send any message via a telephone fax machine unless such message clearly contains in a margin at the top or bottom of each transmitted page or on the first page of the transmission, the date and time it is sent and an identification of the business, other entity or individual sending the message and the telephone number of the sending machine or such business, other entity or individual. In order to program this information into your fax modem, you should complete the setup of your fax software before sending messages.

Instructions for IC CS-03 certified equipment

1. The Industry Canada label identifies certified equipment. This certification means that the equipment meets certain telecommunications network protective, operational and safety requirements as prescribed in the appropriate Terminal Equipment Technical Requirements document(s). The Department does not guarantee the equipment will operate to the user's satisfaction. Before installing this equipment, users should ensure that it is permissible to be connected to the facilities of the local telecommunications company. The equipment must also be installed using an acceptable method of connection. The customer should be aware that compliance with the above conditions may not prevent degradation of service in some situations. Repairs to certified equipment should be coordinated by a representative designated by the supplier. Any repairs or alterations made by the user to this equipment, or equipment malfunctions, may give the telecommunications company cause to request the user to disconnect the equipment.

Users should ensure for their own protection that the electrical ground connections of the power utility, telephone lines and internal metallic water pipe system, if present, are connected together. This precaution may be particularly important in rural areas.



Users should not attempt to make such connections themselves, but should contact the appropriate electric inspection authority, or electrician, as appropriate.

- The user manual of analog equipment must contain the equipment's Ringer Equivalence Number (REN) and an explanation notice similar to the following:

The Ringer Equivalence Number (REN) of the modem, which can vary. For the REN of your modem, refer to your modem's label.



The Ringer Equivalence Number (REN) assigned to each terminal device provides an indication of the maximum number of terminals allowed to be connected to a telephone interface. The termination on an interface may consist of any combination of devices subject only to the requirement that the sum of the Ringer Equivalence Numbers of all the devices does not exceed 5.

- The standard connecting arrangement (telephone jack type) for this equipment is jack type(s): USOC RJ11C.

The IC registration number of the modem is shown below.

IC: 4005B-DELPHI

Notes for Users in Australia and New Zealand

Modem warning notice for Australia

Modems connected to the Australian telecoms network must have a valid Austel permit. This modem has been designed to specifically configure to ensure compliance with Austel standards when the country/region selection is set to Australia. The use of other country/region setting while the modem is attached to the Australian PSTN would result in you modem being operated in a non-compliant manner. To verify that the country/region is correctly set, enter the command AT19 which displays the currently active setting.

To set the country/region permanently to Australia, enter the following command sequence:

```
AT+GCI=09
```

Failure to set the modem to the Australia country/region setting as shown above will result in the modem being operated in a non-compliant manner. Consequently, there would be no permit in force for this equipment and the Telecoms Act 1991 prescribes a penalty of \$12,000 for the connection of non-permitted equipment.

Notes for use of this device in New Zealand

- The grant of a Telepermit for a device in no way indicates Telecom acceptance of responsibility for the correct operation of that device under all operating conditions. In particular the higher speeds at which this modem is capable of operating depend on a specific network implementation which is only one of many ways of delivering high quality voice telephony to customers. Failure to operate should not be reported as a fault to Telecom.
- In addition to satisfactory line conditions a modem can only work properly if:
 - a/ it is compatible with the modem at the other end of the call and
 - b/ the application using the modem is compatible with the application at the other end of the call - e.g., accessing the Internet requires suitable software in addition to a modem.
- This equipment shall not be used in any manner which could constitute a nuisance to other Telecom customers.
- Some parameters required for compliance with Telecom's PTC Specifications are dependent on the equipment (PC) associated with this modem. The associated equipment shall be set to operate within the following limits for compliance with Telecom Specifications:
 - a/ There shall be no more than 10 call attempts to the same number within any 30 minute period for any single manual call initiation, and
 - b/ The equipment shall go on-hook for a period of not less than 30 seconds between the end of one attempt and the beginning of the next.
 - c/ Automatic calls to different numbers shall be not less than 5 seconds apart.
- Immediately disconnect this equipment should it become physically damaged, and arrange for its disposal or repair.
- The correct settings for use with this modem in New Zealand are as follows:
 - ATB0 (CCITT operation)
 - AT&G2 (1800 Hz guard tone)
 - AT&P1 (Decadic dialling make-break ratio = 33%/67%)
 - ATS0=0 (not auto answer)
 - ATS10=less than 150 (loss of carrier to hang up delay, factory default of 15 recommended)
 - ATS11=90 (DTMF dialling on/off duration=90 ms)
 - ATX2 (Dial tone detect, but not (U.S.A.) call progress detect)

- When used in the Auto Answer mode, the S0 register must be set with a value of 3 or 4. This ensures:
 - a person calling your modem will hear a short burst of ringing before the modem answers. This confirms that the call has been successfully switched through the network.
 - caller identification information (which occurs between the first and second ring cadences) is not destroyed.
- The preferred method of dialling is to use DTMF tones (ATDT...) as this is faster and more reliable than pulse (decadic) dialling. If for some reason you must use decadic dialling, your communications program must be set up to record numbers using the following translation table as this modem does not implement the New Zealand "Reverse dialling" standard.

Number to be dialled: 0 1 2 3 4 5 6 7 8 9

Number to program into computer: 0 9 8 7 6 5 4 3 2 1

Note that where DTMF dialling is used, the numbers should be entered normally.

- The transmit level from this device is set at a fixed level and because of this there may be circumstances where the performance is less than optimal. Before reporting such occurrences as faults, please check the line with a standard Telepermitted telephone, and only report a fault if the phone performance is impaired.
- It is recommended that this equipment be disconnected from the Telecom line during electrical storms.
- When relocating the equipment, always disconnect the Telecom line connection before the power connection, and reconnect the power first.
- This equipment may not be compatible with Telecom Distinctive Alert cadences and services such as FaxAbility.

NOTE THAT FAULT CALLOUTS CAUSED BY ANY OF THE ABOVE CAUSES MAY INCUR A CHARGE FROM TELECOM

General conditions

As required by PTC 100, please ensure that this office is advised of any changes to the specifications of these products which might affect compliance with the relevant PTC Specifications.

The grant of this Telepermit is specific to the above products with the marketing description as stated on the Telepermit label artwork. The Telepermit may not be assigned to other parties or other products without Telecom approval.

A Telepermit artwork for each device is included from which you may prepare any number of Telepermit labels subject to the general instructions on format, size and color on the attached sheet.

The Telepermit label must be displayed on the product at all times as proof to purchasers and service personnel that the product is able to be legitimately connected to the Telecom network.

The Telepermit label may also be shown on the packaging of the product and in the sales literature, as required in PTC 100.

The charge for a Telepermit assessment is \$337.50. An additional charge of \$337.50 is payable where an assessment is based on reports against non-Telecom New Zealand Specifications. \$112.50 is charged for each variation when submitted at the same time as the original.

An invoice for \$NZ1237.50 will be sent under separate cover.

Following information is only for EU-member states:

The symbol indicates that this product may not be treated as household waste. Please ensure this product is properly disposed as inappropriate waste handling of this product may cause potential hazards to the environment and human health. For more detailed information about recycling of this product, please contact your local city office, your household waste disposal service or the shop where you purchased the product.



This symbol may not stick depending on the country and region where you purchased.

Optical disc drive safety instructions



Be sure to check the international precautions at the end of this section.

Panasonic

DVD Super Multi UJ-852M/852B



- *The DVD Super Multi drive employs a laser system. To ensure proper use of this product, please read this instruction manual carefully and retain for future reference. Should the unit ever require maintenance, contact an authorized service location.*
- *Use of controls, adjustments or the performance of procedures other than those specified may result in hazardous radiation exposure.*
- *To prevent direct exposure to the laser beam, do not try to open the enclosure.*

Location of the required label

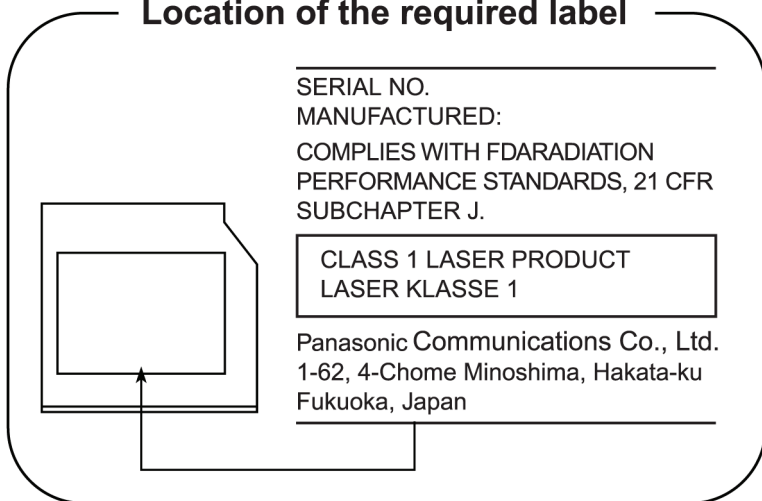

HLDS

DVD Super Multi GSA-U10N



- *The DVD Super Multi drive employs a laser system. To ensure proper use of this product, please read this instruction manual carefully and retain for future reference. Should the unit ever require maintenance, contact an authorized service location.*
- *Use of controls, adjustments or the performance of procedures other than those specified may result in hazardous radiation exposure.*
- *To prevent direct exposure to the laser beam, do not try to open the enclosure.*

Location of the required label

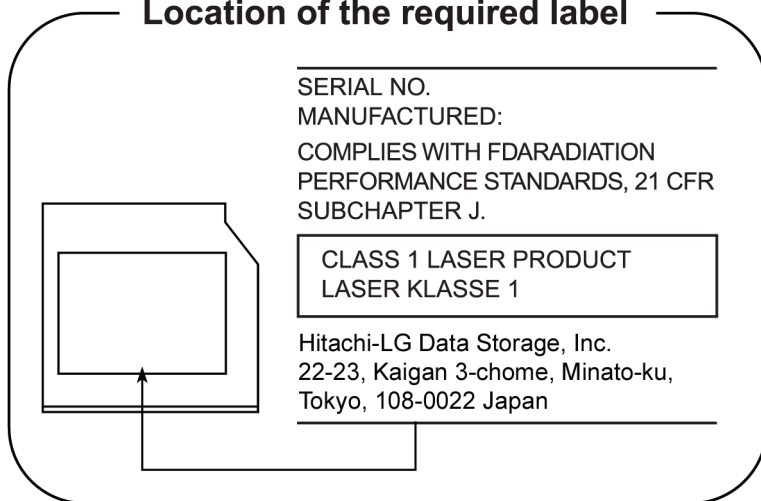

International Precautions

CLASS 1 LASER PRODUCT
LASER KLASSE 1 PRODUKT
TO EN 60825-1
クラス1 レーザ 製品

CAUTION: This appliance contains a laser system and is classified as a "CLASS 1 LASER PRODUCT." To use this model properly, read the instruction manual carefully and keep this manual for your future reference. In case of any trouble with this model, please contact your nearest "AUTHORIZED service station." To prevent direct exposure to the laser beam, do not try to open the enclosure.

CLASS 1 LASER PRODUCT
LASERSCHUTZKLASSE 1
PRODUKT
TOEN60825

VORSICHT: Dieses Gerät enthält ein Laser-System und ist als "LASERSCHUTZKLASSE 1 PRODUKT" klassifiziert. Für den richtigen Gebrauch dieses Modells lesen Sie bitte die Bedienungsanleitung sorgfältig durch und bewahren diese bitte als Referenz auf. Falls Probleme mit diesem Modell auftreten, benachrichtigen Sie bitte die nächste "autorisierte Service-Vertretung". Um einen direkten Kontakt mit dem Laserstrahl zu vermeiden darf das Gerät nicht geöffnet werden.

ADVERSEL: USYNLIG
LASERSTRÅLING VED
ÅBNING, NÅR
SIKKERHEDSAF-BRYDER
ER UDE AF FUNKTION.
UNDGÅ UDSÆTTSELSE FOR
STRÅLING

ADVARSEL: Denne mærkning er anbragt udvendigt på apparatet og indikerer, at apparatet arbejder med laserstråler af klasse 1, hvilket betyder, at der anvendes laserstråler af svageste klasse, og at man ikke på apparatets yderside kan bilve udsat for utilladellig kraftig stråling.

APPARATET BOR KUN ÅBNES AF
FAGFOLK MED SÆRLIGT KENDSKAB
TIL APPARATER MED LASERSTRÅLER!

Indvendigt i apparatet er anbragt den her gengivne advarselsmærkning, som advarer imod at foretage sådanne indgreb i apparatet, at man kan komme til at udsatte sig for laserstråling.

OBS! Apparaten innehåller laserkomponent som avger laserstråning överstigande gränsen för laserklass 1.

VAROITUS. Suojakoteloä si saa avata. Laite sisältää laserdiodin, joka lähettää näkymätöntä silmilie vaarallista lasersäteilyä.

CAUTION: USE OF CONTROLS OR ADJUSTMENTS OR PERFORMANCE OF PROCEDURES OTHER THAN THOSE SPECIFIED IN THE OWNER'S MANUAL MAY RESULT IN HAZARDOUS RADIATION EXPOSURE.

VORSICHT: DIE VERWENDUNG VON ANDEREN STEURUNGEN ODER EINSTELLUNGEN ODER DAS DURCHFÜHREN VON ANDEREN VORGÄNGEN ALS IN DER BEDIENUNGSANLEITUNG BESCHRIEBEN KÖNNEN GEFÄHRLICHE STRAHLENEXPOSITIONEN ZUR FOLGE HABEN.

General Precautions

TOSHIBA computers are designed to optimize safety, minimize strain and withstand the rigors of portability. However, certain precautions should be observed to further reduce the risk of personal injury or damage to the computer.

Be certain to read the general precautions below and to note the cautions included in the text of the manual.

Creating a computer-friendly environment

Place the computer on a flat surface that is large enough for the computer and any other items you are using, such as a printer.

Leave enough space around the computer and other equipment to provide adequate ventilation. Otherwise, they may overheat.

To keep your computer in prime operating condition, protect your work area from:

- Dust, moisture, and direct sunlight.
- Equipment that generates a strong electromagnetic field, such as stereo speakers (other than speakers that are connected to the computer) or speakerphones.
- Rapid changes in temperature or humidity and sources of temperature change such as air conditioner vents or heaters.
- Extreme heat, cold, or humidity.
- Liquids and corrosive chemicals.

Stress injury

Carefully read the *Instruction Manual for Safety and Comfort*. It contains information on the prevention of stress injuries to your hands and wrists that can be caused by extensive keyboard use. Chapter 3, [Getting Started](#), also includes information on work space design, posture and lighting that can help reduce physical stress.

Heat injury

- Avoid prolonged physical contact with the computer. If the computer is used for long periods, its surface can become very warm. While the temperature will not feel hot to the touch, if you maintain physical contact with the computer for a long time, for example if you rest the computer on your lap or if you keep your hands on the palm rest, your skin might suffer a low-heat injury.
- If the computer has been used for a long time, avoid direct contact with the metal plate supporting the various interface ports as this can become hot.
- The surface of the AC adaptor can become hot when in use but this condition does not indicate a malfunction. If you need to transport the AC adaptor, you should disconnect it and let it cool before moving it.
- Do not lay the AC adaptor on a material that is sensitive to heat as the material could become damaged.

Pressure or impact damage

Do not apply heavy pressure to the computer or subject it to any form of strong impact as this can damage the computer's components or otherwise cause it to malfunction.

PC and Express Card overheating

Some PC and Express Cards can become hot during prolonged use which may result in errors or instability in the operation of the device in question. In addition, you should also be careful when you remove a PC or Express Card that has been used for a long time.

Mobile phones

Please be aware that the use of mobile phones can interfere with the audio system. The operation of the computer will not be impaired in any way, but it is recommended that a minimum distance of 30cm is maintained between the computer and a mobile phone that is in use.

Instruction Manual for Safety and Comfort

All important information on the safe and proper use of this computer is described in the enclosed Instruction Manual for Safety and Comfort. Be sure to read it before using the computer.

Table of Contents

	Preface	
	Manual contents	xxv
	Conventions	xxvi
	Abbreviations	xxvi
	Icons	xxvi
	Keys	xxvi
	Key operation	xxvii
	Display	xxvii
	Messages	xxvii
<i>Chapter 1</i>	Introduction	
	Equipment checklist	1-1
	Hardware	1-1
	Software	1-2
	Features	1-3
	Special features	1-8
	Utilities	1-10
	Options	1-13
<i>Chapter 2</i>	The Grand Tour	
	Front with the display closed	2-1
	Left side	2-2
	Right side	2-4
	Backside	2-5
	Underside	2-6
	Front with the display open	2-7

Fixed optical media drives	2-9
Region codes for DVD drive and media	2-9
Writable discs	2-10
CDs	2-10
Formats	2-10
DVD Super Multi drive (Supporting DVD±R Double Layer)	2-11
AC adaptor	2-11
<i>Chapter 3</i> Getting Started	
Installing the battery pack	3-2
Connecting the AC adaptor	3-3
Opening the display	3-4
Turning on the power	3-5
Start up for the first time	3-5
Turning off the power	3-6
Shut Down mode (Boot mode)	3-6
Hibernation mode	3-6
Standby mode	3-8
Restarting the computer	3-9
Create Optical Recovery Discs (depends on the model you purchased)	3-10
Restoring the preinstalled software from the Recovery HDD (depends on the model you purchased)	3-10
Restoring the preinstalled software from Recovery Media	3-11
<i>Chapter 4</i> Operating Basics	
Using the TouchPad	4-1
Using the FingerPrint Reader (depends on model purchased)	4-2
How the Swipe the Finger	4-3
Points to note about the FingerPrint Sensor	4-4
Points to note about the FingerPrint Utility software	4-6
Set up Procedure	4-6
Window Log-on via FingerPrint Authentication	4-7
FingerPrint Power-on Security	4-8
FingerPrint Single Sign-On Feature	4-9
Using the Web Camera (depends on the model purchased)	4-10
Using the software	4-10
Using the microphone	4-11
Using the optical media drive	4-12
Loading discs	4-12
Removing discs	4-15

Writing CD/DVDs with the DVD Super Multi drive supporting DVD±R Double layer	4-16
Important message (DVD Super Multi drive supporting DVD±R Double layer)	4-16
Before writing or rewriting	4-17
When writing or rewriting	4-19
Disclaimer (DVD Super Multi drive supporting DVD±R Double layer)	4-19
TOSHIBA Disc Creator	4-20
Media care	4-21
CD/DVDs	4-21
Modem (depends on the model purchased)	4-22
Region selection	4-22
Properties menu	4-22
Settings	4-23
Modem Selection	4-23
Dialing Properties	4-23
Connecting	4-23
Disconnecting	4-24
Wireless communications	4-25
Wireless LAN	4-25
Security	4-26
Bluetooth® Stack for Windows® by TOSHIBA (depends on the model purchased)	4-26
Wireless communication switch	4-27
Wireless communication indicator	4-27
LAN	4-27
LAN cable types	4-27
Connecting LAN cable	4-28
Disconnecting LAN cable	4-28
Cleaning the computer.	4-29
Moving the computer.	4-29
Using the Hard Disk Drive (HDD) Protection	4-30
TOSHIBA HDD Protection Properties	4-30
Details	4-32

Chapter 5 **The Keyboard**

Typewriter keys	5-1
F1 ... F12 function keys	5-2
Soft keys: Fn key combinations	5-2
Emulating keys on enhanced keyboard	5-2
Hot keys	5-3
Fn Sticky key (Depends on the model you purchased)	5-5

Windows® special keys	5-5
Keypad overlay	5-6
Turning on the overlays	5-6
Temporarily using normal keyboard (overlay on)	5-7
Generating ASCII characters	5-7
<i>Chapter 6</i> Power and Power-Up Modes	
Power conditions	6-1
Power indicators	6-2
Battery indicator	6-2
Power indicator	6-2
Battery types	6-3
Battery pack	6-3
Real Time Clock battery	6-4
Care and use of the battery pack	6-5
Safety precautions	6-5
Charging the batteries	6-7
Monitoring battery capacity	6-9
Maximizing battery operating time	6-9
Retaining data with power off	6-10
Extending battery life	6-10
Replacing the battery pack	6-11
Removing the battery pack	6-11
Installing the battery pack	6-12
Starting the computer by password	6-12
Power-up modes	6-13
Hot keys	6-13
Panel power off/on	6-13
System Auto Off	6-13
<i>Chapter 7</i> HW Setup	
Accessing HW Setup	7-1
HW Setup Window	7-1
<i>Chapter 8</i> Optional Devices	
PC Card and Express Card	8-2
Inserting a PC card and Express Card	8-2
Removing a PC Card or Express Card	8-3
SD/MMC/MS/MS Pro/xD Memory cards	8-4
Installing a memory card	8-5
Removing a memory card	8-5
Memory card care	8-6
Memory expansion	8-7
Installing a memory module	8-7
Removing a memory module	8-9

Additional battery pack	8-10
Additional AC adaptor	8-10
External monitor	8-11
Security lock	8-11

Chapter 9 **Troubleshooting**

Problem solving process	9-1
Preliminary checklist	9-2
Analyzing the problem	9-2
Hardware and system checklist	9-3
System start-up	9-3
Self test	9-4
Power	9-4
Disposing of PC and PC batteries	9-6
Real Time Clock	9-7
Keyboard	9-7
LCD panel	9-8
Hard disk drive	9-8
Recovery Discs	9-9
DVD Super Multi drive (Supporting DVD±R Double Layer)	9-9
Pointing device	9-10
USB	9-12
Memory expansion	9-13
Sound system	9-13
Monitor	9-13
Modem	9-14
LAN	9-15
Wireless LAN	9-15
Fingerprint Sensor	9-16
PC/Express Card	9-16
TOSHIBA support	9-17
Before you call	9-17
Where to write	9-17

Appendix A **Specifications**

Appendix B **Display Controller and Modes**

Appendix C **Wireless LAN**

Appendix D **AC Power Cord and Connectors**

Appendix E **Legal Footnotes**

Glossary

Index

Preface

Congratulations on your purchase of the TOSHIBA Satellite U300 / Satellite Pro U300 / PORTEGE M600 / TECRA M8 Series computer. This powerful notebook computer provides excellent expansion capability, including multimedia devices, and it is designed to provide years of reliable, high-performance computing.

This manual tells how to set up and begin using your TOSHIBA Satellite U300 / Satellite Pro U300 / PORTEGE M600 / TECRA M8 Series computer. It also provides detailed information on configuring your computer, basic operations and care, using optional devices and troubleshooting.

If you are a new user of computers or if you're new to portable computing, first read over the *Introduction* and *The Grand Tour* chapters to familiarize yourself with the computer's features, components and accessory devices. Then read *Getting Started* for step-by-step instructions on setting up your computer.

If you are an experienced computer user, please continue reading the preface to learn how this manual is organized, then become acquainted with this manual by browsing through its pages. Be sure to look over the *Specifications* section of the Introduction, to learn about features that are uncommon or unique to the computer. If you are going to install PC Cards or connect external devices such as a monitor, be sure to read Chapter 8, *Optional Devices*.

Manual contents

This manual is composed of the following nine chapters, five appendixes, a glossary and an index.

Chapter 1, *Introduction*, is an overview of the computer's features, capabilities, and options.

Chapter 2, *The Grand Tour*, identifies the components of the computer and briefly explains how they function.

Chapter 3, *Getting Started*, provides a quick overview of how to begin operating your computer and gives tips on safety and designing your work area.

Chapter 4, *Operating Basics*, includes instructions on using the following devices: TouchPad, Sound System, optical media drives, modem, wireless communication and LAN. It also provides tips on care of the computer, and CD/DVDs.

Chapter 5, *The Keyboard*, describes special keyboard functions including the keypad overlay and hot keys.

Chapter 6, *Power and Power-Up Modes*, gives details on the computer's power resources and battery save modes.

Chapter 7, *HW Setup* explains how to configure the computer using the HW Setup program.

Chapter 8, *Optional Devices*, describes the optional hardware available.

Chapter 9, *Troubleshooting*, provides helpful information on how to perform some diagnostic tests, and suggests courses of action if the computer doesn't seem to be working properly.

The *Appendices* provide technical information about your computer.

The *Glossary* defines general computer terminology and includes a list of acronyms used in the text.

The *Index* quickly directs you to the information contained in this manual.

Conventions

This manual uses the following formats to describe, identify, and highlight terms and operating procedures.

Abbreviations

On first appearance, and whenever necessary for clarity, abbreviations are enclosed in parentheses following their definition. For example: Read Only Memory (ROM). Acronyms are also defined in the Glossary.

Icons

Icons identify ports, dials, and other parts of your computer. The indicator panel also uses icons to identify the components it is providing information on.

Keys

The keyboard keys are used in the text to describe many computer operations. A distinctive typeface identifies the key top symbols as they appear on the keyboard. For example, **Enter** identifies the Enter key.

Key operation

Some operations require you to simultaneously use two or more keys. We identify such operations by the key top symbols separated by a plus sign (+). For example, **Ctrl + C** means you must hold down **Ctrl** and at the same time press **C**. If three keys are used, hold down the first two and at the same time press the third.

ABC

When procedures require an action such as clicking an icon or entering text, the icon's name or the text you are to type in is represented in the type face you see to the left.

Display



ABC

Names of windows or icons or text generated by the computer that appears on its display screen is presented in the type face you see to the left.

Messages

Messages are used in this manual to bring important information to your attention. Each type of message is identified as shown below.



Pay attention! A caution informs you that improper use of equipment or failure to follow instructions may cause data loss or damage your equipment.



Please read. A note is a hint or advice that helps you make best use of your equipment.



Indicates a potentially hazardous situation, which could result in death or serious injury, if you do not follow instructions.

Chapter 1

Introduction

This chapter provides an equipment checklist, and it identifies the computer's features, options and accessories.



Some of the features described in this manual may not function properly if you use an operating system that was not pre-installed by TOSHIBA.

Equipment checklist

Carefully unpack your computer. Save the box and packing materials for future use.

Hardware

Check to make sure you have all the following items:

- TOSHIBA Satellite U300 / Satellite Pro U300 / PORTEGE M600 / TECRA M8 Series Portable Personal Computer
- Universal AC adaptor and power cord
- Modular cable for modem (optional part dependant on model purchased)



It is necessary to install the battery to use this computer. Refer to Installing the battery pack section in Chapter 3, [Getting Started](#).

Software

Microsoft® Windows® XP Home Edition/ Professional

The following software is preinstalled:

- Microsoft® Windows® XP Home Edition/ Professional
- Microsoft Internet Explorer
- TOSHIBA Utilities
- TOSHIBA Hardware Setup
- TOSHIBA Supervisor Password
- TOSHIBA Assist
- TOSHIBA ConfigFree
- DVD Video Player
- TOSHIBA CD/DVD Acoustic Silencer
- TOSHIBA SD Utilities
- TOSHIBA Disc Creator
- Recovery Disc Creator (depends on the model you purchased)
- Online Manual
- Display Driver
- TouchPad Driver
- Sound Driver
- Miscellaneous drivers (depending on the model you purchased: Modem, Wireless LAN)

Other software may be preinstalled dependant on the model purchased.

- Discs
- Windows Anytime Upgrade DVD (Is included with some models)

Documentation

- Satellite U300 / Satellite Pro U300 Series Personal Computer User Information Guide
- Microsoft® Windows® XP manual package (Provided with some models)
- International Limited Warranty (ILW) Instruction (This instruction is included only with computers sold in ILW supported areas.)



If any of the items are missing or damaged, contact your dealer immediately.

Features

Please visit your region's web site for the configuration details of the model that you have purchased.

Processor

Built-in	Depend on the model you purchased. Intel® Core™ 2 Duo Processor Intel® Core™ Duo Processor Intel® Pentium® Dual Core Processor Intel® Celeron® M Processor TJ85 Seam CPU support
Chipset	Mobile Intel® GM965 Express Chipset Mobile Intel® 945GM Express Chipset Mobile Intel® 943GML Express Chipset

Memory

Main Memory Disclaimer	Part of the main system memory may be used by the graphics system for graphics performance and therefore reduce the amount of main system memory available for other computing activities. The amount of main system memory allocated to support graphics may vary depending on the graphics system, applications utilized, system memory size and other factors. For PC's configured with 4 GB of system memory, the full system memory space for computing activities will be considerably less and will vary by model and system configuration.
Slots	Up to two 2048 MB memory modules can be installed in the memory slot for a maximum of 4 GB system memory total.
Video RAM	Depending on the model you purchased: Mobile Intel® GM965/GL960/945GM/943GML Express Chipset, up to 251MB shared with main memory. (for more than 1GB main memory)

Power

Battery Pack	Your computer is powered by a rechargeable lithium-ion battery pack.
RTC Battery	The internal RTC battery backs up the Real Time Clock and calendar.
AC Adaptor	The universal AC adaptor provides power to the system and recharges the batteries when they are low. It comes with a detachable power cord. Because it is universal, it can receive a range of AC voltage from 100 to 240 volts; however, the output current varies among different models. Using the wrong model can damage your computer. Refer to the AC adaptor section in Chapter 2, <i>The Grand Tour</i> .

Disks

Hard disk Disclaimer	1 Gigabyte (GB) means $10^9 = 1,000,000,000$ bytes using powers of 10. The computer operating system, however, reports storage capacity using powers of 2 for the definition of 1 GB = $2^{30} = 1,073,741,824$ bytes, and therefore shows less storage capacity. Available storage capacity will also be less if the product includes one or more pre-installed operating systems, such as Microsoft Operating System and/or pre-installed software applications, or media content. Actual formatted capacity may vary.
Hard disk Drive	Available in six sizes. <ul style="list-style-type: none"> ■ 60.0 billion bytes (55.89 GB) ■ 80.0 billion bytes (74.51 GB) ■ 100.0 billion bytes (93.13 GB) ■ 120.0 billion bytes (111.75 GB) ■ 160.0 billion bytes (149.01 GB) ■ 200.0 billion bytes (186.26 GB) Other hard disk drives may be introduced in the future.



Computers in this series can be configured with a fixed optical media drive. The available optical media drives are described below.

DVD Super Multi drive (Supporting DVD±R Double Layer)

Some models are equipped with a full-size DVD Super Multi drive module that lets you record data to rewritable CD/DVDs as well as run either 12cm (4.72") or 8cm (3.15") CD/DVDs without using an adaptor. It reads DVD-ROM's at maximum 8 speed and CD-ROM's at maximum 24 speed. It writes CD-R's at up to 24 speed, CD-RW's at up to 16 speed, DVD-R's at maximum 8 speed, DVD-RW's at maximum 6 speed. DVD+R's at maximum 8 speed, DVD+RW's at maximum 8 speed, DVD+R(DL) discs at maximum 4 speed and DVD-R(DL) discs at maximum 4 speed.

DVD-RAM at maximum 5 speed. This drive supports the following formats in addition to DVD-ROM & CD-R/RW drive.

- DVD+R
 - DVD+RW
 - DVD-RAM
 - DVD-R
 - DVD-RW
 - DVD+R (DL)
 - DVD-R (DL)
-



Display

The computer's LCD panel supports high-resolution video graphics. The screen can be set at a wide range of viewing angles for maximum comfort and readability.

Built-In 13.3" WXGA 16 M colors, with the following resolution:
1280 horizontal × 800 vertical pixels

Graphics Controller Graphics controller maximizes display performance. Refer to *Display Controller and Modes* section in Appendix B, *Display Controller and Modes* for more information.

Keyboard

Built-In 84 keys or 85 keys, compatible with IBM enhanced keyboard, embedded numeric overlay, dedicated cursor control,  and  keys. Refer to Chapter 5, *The Keyboard*, for details.

Pointing Device

Built-In TouchPad	A TouchPad and control buttons in the palm rest enable control of the on-screen pointer and scrolling of windows.
--------------------------	---

Ports

External Monitor	Depending on the model you purchased: 15-pin, analog VGA port supports VESA DDC2B compatible functions.
-------------------------	--

Universal Serial Bus (USB 2.0)	The computer has Universal Serial Bus ports that comply with the USB 2.0 standard, which enables data transfer speeds 40 times faster than the USB 1.1 standard. (The ports also support USB 1.1.)
---------------------------------------	--

i.LINK (IEEE1394a)	This port enables high-speed data transfer directly from external devices such as digital video cameras.
---------------------------	--

Slots

Express Card	The Express Card expansion slot that can accommodate two standard module formats; an Express Card/34 module and an Express Card/54 module. An Express Card module is a small add-in card technology based on the PCI Express and Universal Serial Bus (USB) interfaces. (Depends on the model purchased)
---------------------	---

PC Card	The PC Card slot accommodates Type II card. (Depends on the model purchased)
----------------	---

Multiple Digital Media Card Slot	Supports SD Mini SD(with adaptor), MMS, MS, MS Pro, xD cards.
---	---

Multimedia

Web Camera	Record/Send still or video images with this integrated webcam. (Depends on the model purchased)
-------------------	--

Sound System	A Windows® Sound System that provides speakers as well as jacks for an external microphone and headphones.
---------------------	--

Headphone Jack	This jack outputs analog audio signals.
Microphone Jack	A 3.5 mm mini microphone jack enables connection of a three-conductor mini jack for monaural microphone input.

Communications

Modem	The internal modem feature is not available on all models. Where present, it provides capability for data and fax communication. It supports V.90 (V.92). The speed of data transfer and fax communication depends on the analog telephone line conditions. The computer has a modem jack for connection to a telephone line. Both V.90 and V.92 are supported only in the USA, Canada, Australia. V.90 is available in other regions.
LAN	The computer has built-in support for Ethernet LAN (10 megabits per second, 10BASE-T) and Fast Ethernet LAN (100 megabits per second, 100BASE-TX).
Wireless LAN	<p>The Wireless LAN feature is not available on all models. Where present, it supports the A,B,G and N standards but it is compatible with other LAN systems based on Direct Sequence Spread Spectrum / Orthogonal Frequency Division Multiplexing radio technology that complies with the IEEE 802.11 Standard.</p> <ul style="list-style-type: none">■ Automatic Transmit Rate Select mechanism in the transmit range of 54, 48, 36, 24, 18, 12, 9 and 6 Mbit/s. (IEEE 802.11g)■ Automatic Transmit Rate Select mechanism in the transmit range of 11, 5.5, 2 and 1 Mbit/s. (IEEE 802.11b)■ Roaming over multiple channels■ Card Power Management■ Wired Equivalent Privacy (WEP) data encryption, based on 128 bit encryption algorithm.■ Advanced Encryption Standard (AES) data encryption, based on 128 bit encryption algorithm.

Security

Password	Power-on password protection Two level password architecture Fingerprint authentication (not available on all models)
-----------------	---

Special features

The following features are either unique to TOSHIBA computers or are advanced features, which make the computer more convenient to use.

Hot Keys	Key combinations let you quickly modify the system configuration directly from the keyboard without running a system configuration program.
Keypad Overlay	A ten-key pad is integrated into the keyboard. Refer to the <i>Keypad overlay</i> section in Chapter 5, The Keyboard, for instructions on using the keypad overlay.
Instant Security	The hot key function Fn + F1 blanks the screen and disables the computer, providing data security.
Display Automatic Power Off *1	This feature automatically cuts off power to the internal display when there is no keyboard input for a specified time. Power is restored when any key is pressed. This can be specified in the Power Options.
HDD Automatic Power Off *1	This feature automatically cuts off power to the hard disc drive when it is not accessed for a specified time. Power is restored when the hard disc is accessed. This can be specified in the Power Options.
System Automatic Standby Mode/ Hibernation *1	This feature automatically shuts down the system into Standby Mode or Hibernation Mode when there is no input or hardware access for a specified time. This can be specified in the Power Options.

Intelligent Power Supply *1	A microprocessor in the computer's intelligent power supply detects the battery's charge and calculates the remaining battery capacity. It also protects electronic components from abnormal conditions, such as voltage overload from an AC adaptor. This can be specified in the Power Options.
Battery Save Mode *1	This feature lets you save battery power. This can be specified in the Power Options.
Panel Power On/Off *1	This feature turns power to the computer off when the display panel is closed and turns it back on when the panel is opened. This can be specified in the Power Options.
Low Battery Automatic Hibernation *1	When battery power is exhausted to the point that computer operation cannot be continued, the system automatically enters Hibernation Mode and shuts down. This can be specified in the Power Options.
TOSHIBA HDD Protection	This feature uses the acceleration sensor built in the computer to detect vibration and shocks, and automatically moves the hard disk drive's read/write head to a safe position in order to reduce the risk of damage that could be caused by headto-disk contact. Refer to the Using the Hard Disk Drive (HDD) Protection section in Chapter 4, Operating Basics , for more details.
	<i>The TOSHIBA HDD Protection function does not guarantee that the hard disk drive will not be damaged.</i>
Hibernation	This feature lets you turn off the power without exiting from your software. The contents of main memory are saved to the hard disk so that when you turn on the power again, you can continue working right where you left off. Refer to the Turning off the power section in Chapter 3, Getting Started , for details.
Standby Mode	If you have to interrupt your work, you can turn off the power without exiting from your software. Data is maintained in the computer's main memory so that when you turn on the power again, you can continue working right where you left off.



*1 Click **start, Control Panel, Performance and Maintenance, Power Options and Alarm tab.**

Utilities

This section describes preinstalled utilities and tells how to start them. For details on operations, refer to each utility's online manual, help files or readme.txt files.

TOSHIBA Power Saver	TOSHIBA Power Saver provides you with the features of more various power supply managements.
TOSHIBA Zooming Utility	<p>This utility allows you to enlarge or reduce the icon size on the desktop or the application window.</p> <p>To run TOSHIBA Zooming Utility, click start, select All Programs followed by TOSHIBA followed by Utilities and then click Zooming Utility.</p>
TOSHIBA PC Diagnostic Tool	TOSHIBA PC Diagnostic Tool displays the basic information on the computer's configuration and allows some of the built-in devices functionality to be tested. To start the TOSHIBA PC Diagnostic Tool, click start , point to All Programs , point to TOSHIBA , and point to Utilities and click PC Diagnostic Tool .
TOSHIBA Accessibility	The TOSHIBA Accessibility utility provides support to movement impaired users when they need to use the TOSHIBA Hot-key functions. In use, the utility allows you to make the Fn key 'sticky', that is you can press it once, release it, and then press one of the 'F' keys in order to access its specific function. When set, the Fn key will remain active until another key is pressed.
TOSHIBA Assist	TOSHIBA Assist is a graphical user interface that provides easy access to help and services.
HW Setup	This program lets you customize your hardware settings according to the way you work with your computer and the peripherals you use. To start the utility, double click the TOSHIBA Assist on your desktop, select OPTIMIZE tab, and click TOSHIBA Hardware Settings .

Power On Password Two levels of password security, supervisor and user, are available to prevent unauthorized access to your computer.

To register a supervisor password, double click the **TOSHIBA Assist** on your desktop select the **SECURE** tab and start the **Supervisor password** utility.

To set a user password, select the **SECURE** tab on TOSHIBA Assist, then start the **User password** utility. On the **Password** tab you can register a user password.

FingerPrint utility (depends on the model you purchased)

This product has a fingerprint utility installed for the purpose of enrolling and recognizing fingerprints. (depending on the model purchased.) By enrolling the ID and password to the fingerprint authentication device, it is no longer necessary to input the password from the keyboard. Just by swiping the finger against the fingerprint sensor, the following functions will be enabled:

- Log-on to Windows and access a security enabled homepage through IE (Internet Explorer).
- Files and folders can be encrypted/decrypted and third party access to them prevented.
- Disable the password-protected screensaver when returning from power-saving (Standby) mode.
- System boot authentication and Single Touch Boot feature.
- Power on Security and Single Sign On feature.

TOSHIBA DVD Player

The DVD Video Player is used to play DVD Video. It has an on-screen interface and functions. Click **start**, point to **All Programs**, point to **InterVideo WinDVD**, then click **InterVideo WinDVD**.

TOSHIBA Disc Creator

You can create CD/DVDs in several formats including audio CDs that can be played on a standard stereo CD player and data CDs or DVDs to store multimedia and/or document files on your hard disk drive. This software can be used on a model with the CD-RW/DVD-ROM drive, DVD-R/-RW drive, DVD±R/±RW drive and DVD Super Multi drive.

To run TOSHIBA Disc Creator, click **start**, select **All Programs, TOSHIBA, CD&DVD Applications**, and then click **Disc Creator**.

TOSHIBA ConfigFree

ConfigFree is a suite of utilities to allow easy control of communication device and network connections. ConfigFree also allows you to find communication problems and create profiles for easy switching between location and communication networks.

To run ConfigFree, click **start**, select **All Programs** followed by **TOSHIBA** followed by **Networking** and then click **ConfigFree**.

TOSHIBA TouchPad On/Off Utility

Pressing Fn + F9 enables or disables the TouchPad function. When you press these hot keys, the current setting will change and be displayed as an icon.

Options

You can add a number of options to make your computer even more powerful and convenient to use. Refer to Chapter 8 *Optional Devices*, for details. The following options are available:

Memory expansion	Two memory modules can be installed in this computer.
-------------------------	---



Use only PC5300 compatible DDRII memory modules. See your TOSHIBA dealer for details.*

** The availability of DDRII depends on the model you purchased.*

Battery pack	An additional battery pack can be purchased from your TOSHIBA dealer. Use it as a spare to increase your computer operating time.
---------------------	---

AC Adaptor	If you use your computer at more than one site frequently, it may be convenient to purchase an additional AC adaptor for each site so you will not have to carry the adaptor with you.
-------------------	--

Chapter 2

The Grand Tour

This chapter identifies the various components of your computer. Become familiar with each component before you operate the computer.

Front with the display closed

The following figure shows the computer's front with its display panel in the closed position.

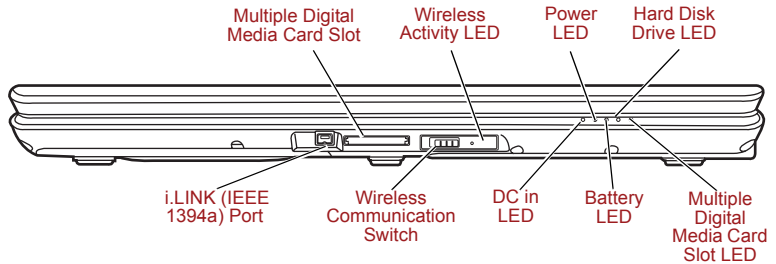

Front of the computer with display closed



i.LINK (IEEE1394a) Port

This port allows you to connect an external device, such as a digital video camera, for highspeed data transfer.
(Depends on the model you purchased)



Multiple Digital Media Card Slot

Supports SD, mini SD (thru adaptor), MMS, MS, MS PRO, xD media cards.



Wireless Communication Switch

The Wireless Communication Switch turns on the wireless networking transceiver. (Depends on the model you purchased.)



Set the switch to off in airplanes and hospitals. Check the wireless activity indicator. It will stop glowing when the wireless communication function is off.



Wireless Activity LED

Indicates whether the wireless LAN or Bluetooth is active or not.
(Depends on the model you purchased.)



DC IN LED

The DC IN LED indicates the computer is connected to the AC adaptor and it is plugged into an AC power source.



Power LED

The Power indicator glows blue when the computer is on. If you select Standby Mode from Turn Off Computer, this indicator flashes orange (one second on, two seconds off) while the computer enters Standby Mode.



Battery LED

The Battery indicator shows the condition of the battery's charge: Blue indicates a full charge, orange indicates that the battery is charging and flashing orange indicates a low battery charge. Refer to Chapter 6, *Power and Power-Up Modes*.



Hard Disk Drive LED

The Hard Disk Drive LED indicates that the hard disk drive is being accessed. Every time your computer runs a program, opens a file, or performs some other function in which it must access the hard disk drive, this light will go on.



Multiple Digital Media Card Slot LED

Multiple Digital Media Card Slot LED lights up when the Multiple Digital Media Card Slot is accessed.
(Depends on the model you purchased.)

Left side

The following figure shows the computer's left side.

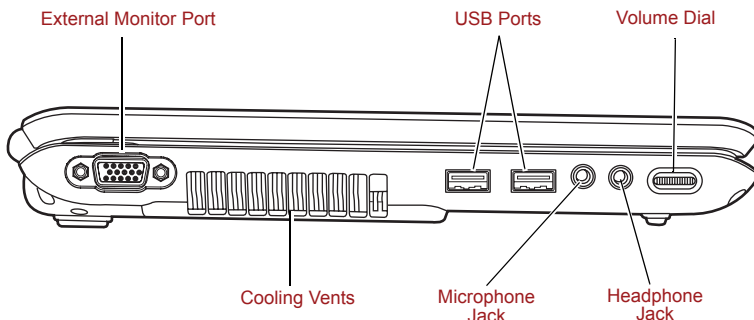

The left side of the computer

**External Monitor Port**

This 15-pin port lets you connect an external video display. The Analog VGA port supports VESA DDC2B compatible functions. (Depends on the model you purchased.)

Cooling Vents

Cooling vents help prevent the CPU from overheating.



Do not block the cooling vents. Also ensure that foreign objects are kept out of the vents as items such as pins or similar objects, which can damage the computer's circuitry.

**Universal Serial Bus (USB 2.0) ports**

Two Universal Serial Bus ports are on the left side. The ports comply with the USB 2.0 standard, which enable data transfer speeds 40 times faster than the USB 1.1 standard (The ports also support USB 1.1). Keep foreign objects out of the USB connectors. A pin or similar object can damage the computer's circuitry. Operation of all functions of all USB devices has not been confirmed. As such, some untested third-party devices may not function properly.

**Microphone Jack**

A 3.5 mm mini microphone jack enables connection of a three-conductor mini jack for monaural microphone input.

**Headphone Jack**

This jack outputs analog audio signals.

**Volume Dial**

Use this dial to adjust the volume of the stereo speakers or headphones.

Right side

The following figure shows the computer's right side.

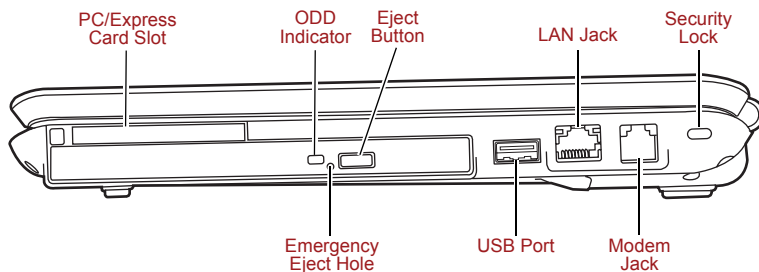

The right side of the computer



PC/Express Card Slot for Cardbus Card Slot

This slot allows you to insert an Express Card. An Express Card is a small, modular add-in card technology based on PCI Express and the Universal Serial Bus (USB) interface. The max. transmission rate is 2.5Gbps. Express Card/34 and Express Card/54 types are supported. A PC Card slot can accommodate Type II cards. The slot supports 16-bit PC Cards and CardBus PC Cards.
(Depends on the model purchased)

ODD Indicator

The ODD indicator glows amber when the computer accesses the optical disc drive.

Emergency Eject Hole

In the event that the disc drive becomes inexplicably locked or stops responding press this button to force a manual ejection of the ODD tray.

Eject Button

Press this button to open the ODD tray.



Universal Serial Bus (USB 2.0) port

A single of Universal Serial Bus port is on the right side. The port complies with the USB 2.0 standard, which enables data transfer speeds 40 times faster than the USB 1.1 standard (The ports also support USB 1.1). Keep foreign objects out of the USB connectors. A pin or similar object can damage the computer's circuitry. Operation of all functions for all USB devices has not been confirmed. As such, some untested third-party devices may not function properly.



LAN Jack

This jack lets you connect to a LAN. The adaptor has built-in support for Ethernet LAN (10 megabits per second, 10BASE-T) and Fast Ethernet LAN (100 megabits per second, 100BASE-TX). Refer to Chapter 4, *Operating Basics*, for details.



Modem Jack

The modem jack allows you to use a modular cable to connect the modem directly to a telephone line. (Depends on the model you purchased.)

- In case of a lightning storm, unplug the modem cable from the telephone jack.
- Do not connect the modem to a digital telephone line. A digital line will damage the modem.



Security Lock

A security cable attaches to this port. The optional security cable anchors your computer to a desk or other large object to deter theft.

Backside

The following figure shows the computer's back panel.

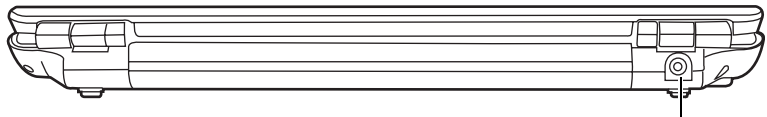

DC in 19V Jack

The backside of the computer



DC IN 19V Jack

The AC adaptor connects to this socket. Use only the model of AC adaptor that comes with the computer. Using the wrong adaptor can damage your computer.

Underside

The following figure shows the underside of the computer. Make sure the display is closed before turning over your computer.

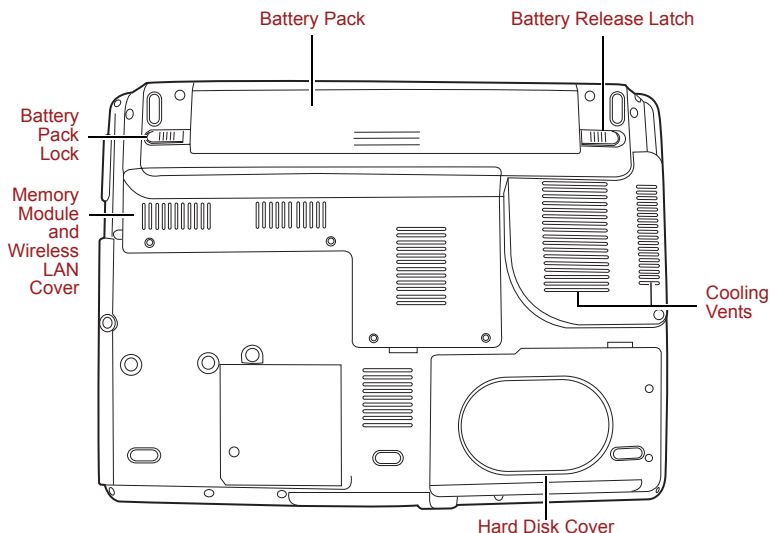

The underside of the computer



Memory Module and Wireless LAN Cover

This cover protects two memory module sockets -- one or two modules are pre-installed. Refer to the [Memory expansion](#) section in Chapter 8, [Optional Devices](#).



Battery Pack Lock

Slide this lock to prepare the battery pack for removal.

Battery Pack

The battery pack powers the computer when the AC adaptor is not connected. For detailed information on the battery pack, refer to Chapter 6, [Power and Power-Up Modes](#).



Battery Release Latch

Slide and hold this latch to release the battery pack for removal. For detailed information on removing the battery pack, refer to Chapter 6, [Power and Power-Up Modes](#).

Cooling Vents

Cooling vents help prevent the CPU from overheating.

Hard Disk Cover

This cover protects the hard disk.





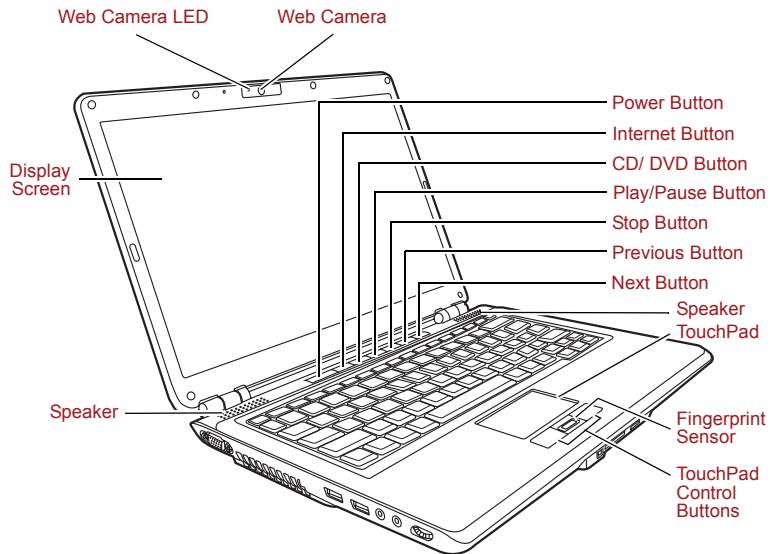



Front with the display open

This section shows the front of the computer with the display open. Refer to the appropriate illustration for details. To open the display, lift the front of the display. Position the display at a comfortable viewing angle.



The front of the computer with the display open

Speakers	The speakers emit sound generated by your software as well as audio alarms, such as low battery condition, generated by the system.
Display Screen	The LCD displays high-contrast text and graphics. Refer to Appendix B, Display Controller and Modes . When the computer operates on the AC adaptor the display screen's image will be somewhat brighter than when it operates on battery power. The lower brightness level is intended to save battery power.
Web Camera LED	Web Camera LED indicates web camera is working or not. (Depends on the model you purchased.)
Web Camera	Take your picture or send your image to web contacts. (Depends on the model you purchased.)

	Power Button	Turns the computer on and off and puts it into Hibernation mode and wakes it up from Standby Mode.
	Internet Button	Press this button to launch an Internet browser. If the computer's power is off, you can press this button to turn on the computer's power and launch the browser automatically in one step. (Depends on the model you purchased.)
	CD/ DVD Button	Pressing this button will launch an application program that allows for playing of CDs or DVDs. The application that is launched differs by model: Windows Media Player/TOSHIBA DVD Player. (Depends on the model purchased.)
	Play/Pause Button	Press this button to begin playing an audio CD, a DVD movie or digital audio file. This button also acts as a Pause button. (Depends on the model purchased.)
	Stop Button	Stops playing of the CD, DVD or digital audio. (Depends on the model purchased.)
	Previous Button	Skips backwards to the previous track, chapter or digital file. Refer to Chapter 4, <i>Operating Basics</i> , for details. (Depends on the model purchased.)
	Next Button	Skips forward to the next track, chapter or digital file. Refer to Chapter 4, <i>Operating Basics</i> , for details. (Depends on the model purchased.)
	Presentation Button	Press this button to switch Windows screen to clone mode display. Default setting is "clone mode display 1024 x 768" at internal and external display. You can also set extended mode at external display. Press again to switch external display only. (Depends on the model purchased.)
	TOSHIBA Assist Button	Press this button to launch TOSHIBA Assist application. If the computer's power is off, you can press this button to turn on the computer's power and launch the TOSHIBA Assist application automatically in one step. (Depends on the model purchased.)

TouchPad	A TouchPad located in the centre of the palm rest is used to control the on-screen pointer.
Fingerprint Sensor	Just by swiping the finger against the fingerprint sensor, the following functions will be enabled: Log-on to Windows and access a security-enabled homepage through IE (Internet Explorer) Files and folders can be encrypted/decrypted and third party access to them prevented. Disable the password-protected screensaver when returning from power-saving (Standby) mode. System boot authentication and Single Touch Boot feature. Authentication of the User Password and Hard Disk Drive Password when booting up the computer. Refer to the Using the FingerPrint Reader (depends on model purchased) section in Chapter 4, Operating Basics . (Depends on the model you purchased.)
TouchPad Control Buttons	These let you select menu items or manipulate text and graphics designated by the on-screen pointer. Refer to the Using the TouchPad section in Chapter 4, Operating Basics .

Fixed optical media drives

One of the following optical media drives is installed in the computer, either a CD-ROM drive or DVD-ROM&CD-R/RW drive or a DVD Super Multi drive. An ATAPI interface controller is used for CD/DVD operation. When the computer is accessing a CD/DVD, an indicator on the drive glows.

Region codes for DVD drive and media

DVD-ROM&CD-R/RW drive and the DVD Super Multi drives and their associated media are manufactured according to the specifications of six marketing regions. When you purchase DVD-Video, make sure it matches your drive, otherwise it will not play properly.

Code	Region
1	Canada, United States
2	Japan, Europe, South Africa, Middle East
3	Southeast Asia, East Asia
4	Australia, New Zealand, Pacific Islands, Central America, South America, Caribbean
5	Russia, Indian Subcontinent, Africa, North Korea, Mongolia
6	China

Writable discs

This section describes the types of writable CD discs. Check the specifications of your drive for the type of discs it can write. Use TOSHIBA Disc Creator to write compact discs. Refer to Chapter 4, *Operating Basics*.

CDs

- CD-R discs can be written only once. The recorded data cannot be erased or changed.
- CD-RW discs can be recorded more than once. Use either 1, 2, or 4 multi speed CD-RW discs or high-speed 4- to 10-speed discs. The write speed of the ultra-speed CD-RW discs (Ultra-speed is available on the DVD-ROM & CD-R/RW drive only) is a maximum of 24-speed.

Formats

The drives support the following formats:

- DVD-ROM*
- CD-DA
- Photo CD™ (single/multi-session)
- CD-ROM X A Mode 2 (Form1, Form2)
- CD-R (Audio CD only)
- DVD -Video*
- CD-Text
- CD-ROM Mode 1, Mode 2
- Enhanced CD (CD-EXTRA)
- CD-RW

* Not available on the CD-ROM drive.

DVD Super Multi drive (Supporting DVD±R Double Layer)

The full-size DVD Super Multi drive module lets you record data to writable CD/DVDs as well as run either 12 cm (4.72") or 8 cm (3.15") CD/DVDs without using an adaptor.



The read speed is slower at the centre of a disc and faster at the outer edge.

DVD read	8 speed (maximum)
DVD-R write	8 speed (maximum)
DVD-RW write	6 speed (maximum)
DVD+R write	8 speed (maximum)
DVD+RW write	8 speed (maximum)
DVD-R(DL) write	4 speed (maximum)
DVD+R(DL) write	4 speed (maximum)
DVD-RAM write	5 speed (maximum)
CD read	24 speed (maximum)
CD-R write	24 speed (maximum)
CD-RW write	16 speed (maximum, Ultra-speed media)

AC adaptor

The AC adaptor converts AC power to DC power and reduces the voltage supplied to the computer. It can automatically adjust to any voltage from 100 to 240 volts and to a frequency of either 50 or 60 hertz, enabling you to use the computer in almost any country/region.

To recharge the battery, simply connect the AC adaptor to a power source and the computer. Refer to Chapter 6, *Power and Power-Up Modes*, for details.

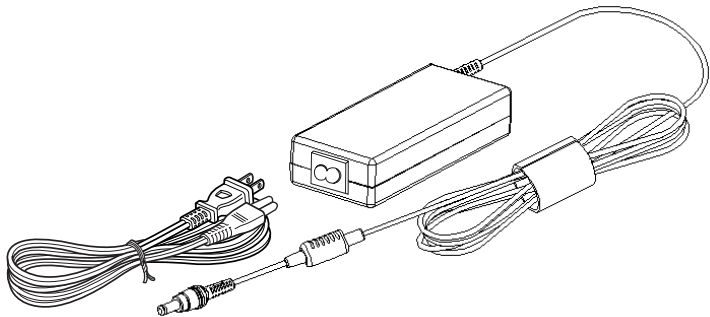

The AC adaptor



- *Use only the AC adaptor that came with the computer or an equivalent optional adaptor. Use of the wrong adaptor could damage your computer. TOSHIBA assumes no liability for any damage in such case.*
- *Use only the AC Adaptor supplied with your computer or an equivalent adaptor that is compatible. Use of any incompatible adaptor or other types of AC Adaptors may have a different voltage which could cause damage to your computer, computer failure and/or possible data loss. TOSHIBA assumes no liability for any damage, computer failure and/or data loss caused by use of an incompatible adaptor.*



Use only the AC adaptor supplied as an accessory. Other AC adaptors have different voltage and terminal polarities and use of them may produce heat and smoke or even result in fire or rupture.

Chapter 3

Getting Started

This chapter provides basic information to get you started using your computer. It covers the following topics:



Be sure also to read the Safety Instruction Manual. This guide, which is included with the computer, explains product liability.

- Installing the battery pack
- Connecting the AC adaptor
- Opening the display
- Turning on the power
- Starting up for the first time
- Turning off the power
- Restarting the computer
- System Recovery Options
- Create Optical Recovery Discs (depends on the model you purchased)
- Restoring the preinstalled Software from the Recovery HDD (depends on the model you purchased)
- Restoring the Preinstalled Software from Recovery Media



All users should be sure to read the section Starting up for the first time.

Installing the battery pack

To install a battery, follow the steps below.



- *The battery pack is a lithium ion battery, which can explode if not properly replaced, used, handled or disposed of. Dispose of the battery as required by local ordinances or regulations. Use only batteries recommended by TOSHIBA as replacements.*
- *Do not touch the latch while holding the computer. Or you may get injured by the dropped battery by unintentional release of the latch.*
- *Please do not push the power button before installing the battery pack.*

1. Turn the computer's power off.
2. Disconnect all cables connected to the computer.
3. Insert the battery pack. The Battery Release Latch clicks into place.
4. Secure the Battery Pack Lock to ensure the battery is locked into place. Later, when you want to remove the battery you must disengage this lock first.

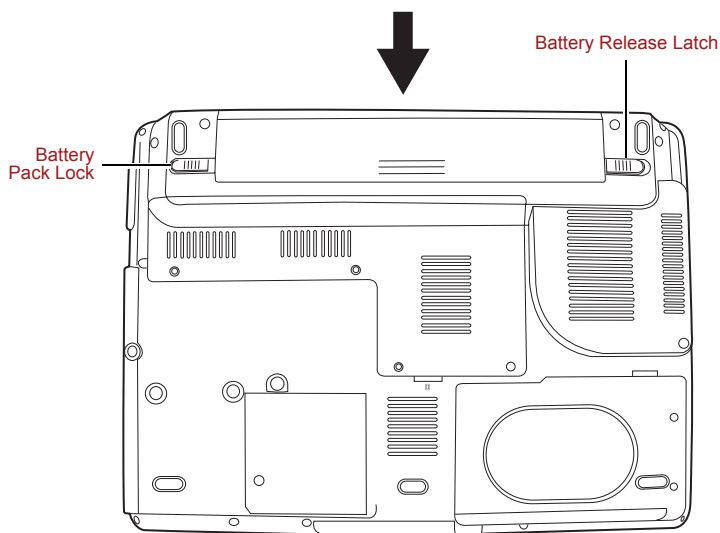

Securing the battery pack



Refer to [Removing the battery pack](#) section in Chapter 6, [Power and Power-Up Modes](#), for removing the battery pack.

Connecting the AC adaptor

Attach the AC adaptor when you need to charge the battery or you want to operate from AC power. It is also the fastest way to get started, because the battery pack will need to be charged before you can operate from battery power.

The AC adaptor can be connected to any power source supplying from 100 to 240 volts and 50 or 60 hertz. For details on using the AC adaptor to charge the battery pack, refer to Chapter 6, *Power and Power-Up Modes*.



Use only the AC adaptor supplied as an accessory. Other AC adaptors have different voltage and terminal polarities and use of them may produce heat and smoke or even result in fire or rupture.



■ *Use only the AC adaptor supplied with your computer or an equivalent adaptor that is compatible. Use of any incompatible adaptor could damage your computer. TOSHIBA assumes no liability for any damage caused by use of an incompatible adaptor.*

■ *When you connect the AC adaptor to the computer, always follow the steps in the exact order as described in the User's Manual. Connecting the power cable to a live electrical outlet should be the last step otherwise the adaptor DC output plug could hold an electrical charge and cause an electrical shock or minor bodily injury when touched. As a general safety precaution, avoid touching any metal parts.*

1. Connect the power cord to the AC adaptor.

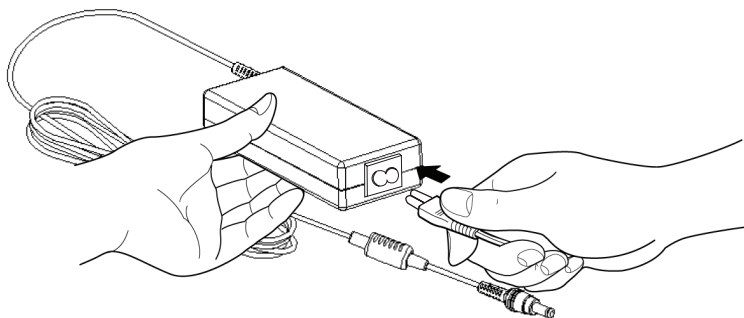

Connecting the power cord to the AC adaptor

2. Connect the AC adaptor's DC output plug to the **DC IN 19V** jack on the back of the computer.

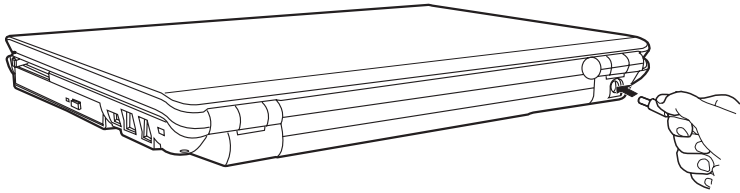

Connecting the adaptor to the computer

3. Plug the power cord into a live wall outlet.

Opening the display

The display panel can be rotated in a wide range of angles for optimal viewing.

1. Lift the panel up and adjust it to the best viewing angle for you.



Use reasonable care when opening and closing the display panel. Opening it vigorously or slamming it shut could damage the computer.

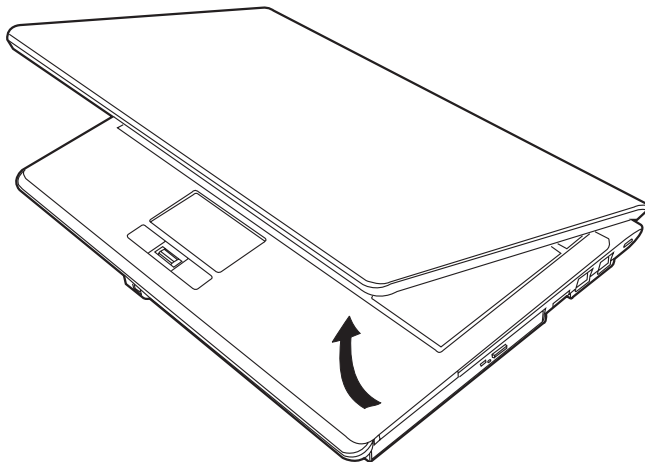

Opening the display

Turning on the power

This section describes how to turn on the power.



After you turn on the power for the first time, do not turn it off until you have set up the operating system. Refer to the section [Start up for the first time](#).

Press and hold the computer's power button for two or three seconds.

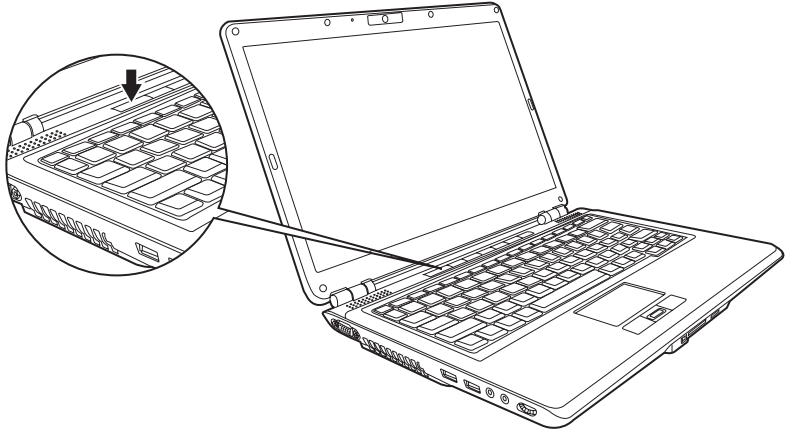

Turning on the power

Start up for the first time

When you first turn on the power, the computer's initial screen is the Windows® XP Startup Screen Logo. Follow the on-screen directions. During setup, you can click the **Back** button to return to the previous screen.

Be sure to read the **Windows® Operating System End User License Agreement** carefully.

Turning off the power

The power can be turned off in one of the following modes: Shut down (Boot), Hibernation or Standby Mode.

Shut Down mode (Boot mode)

When you turn off the power in Shut Down mode no data is saved and the computer will boot to the operating system's main screen.

1. If you have entered data, save it to the hard disk.
2. Make sure all disk (disc) activity has stopped, then remove the CD/DVDs.



*Make sure the **Built-in HDD/ODD** indicators are off. If you turn off the power while a disk (disc) is being accessed, you can lose data or damage the disk (disc).*

3. Click **start** and click **Turn off Computer**. From the **Turn off Computer** dialogue box, choose **Turn Off**.
4. Turn off the power to any peripheral devices.



Do not turn the computer or devices back on immediately. Wait a moment to let all capacitors fully discharge.

Hibernation mode

The hibernation feature saves the contents of memory to the hard disk when the computer is turned off. The next time the computer is turned on, the previous state is restored. The hibernation feature does not save the status of peripheral devices.



1. *While entering hibernation mode, the computer saves the contents of memory to the Hard Disk Drive. Data will be lost if you remove the battery or disconnect the AC adapter before the save is completed. Wait for the **Built-in Hard Disk Drive** indicator to go out.*
2. *Do not install or remove a memory module while the computer is in hibernation mode. Data will be lost.*

Benefits of Hibernation

The hibernation feature provides the following benefits:

- Saves data to the hard disk when the computer automatically shuts down because of a low battery.



For the computer to shut down in hibernation mode, the hibernation feature must be enabled in Power Options: Hibernate tab. Otherwise, the computer will shut down in Standby mode. If battery power becomes depleted, data saved in Standby will be lost.

- You can return to your previous working environment immediately when you turn on the computer.
- Saves power by shutting down the system when the computer receives no input or hardware access for the duration set by the System hibernate feature.
- You can use the panel power off feature.

Starting Hibernation



You can also enable Hibernation by pressing Fn + F4. See Chapter 5, [The Keyboard](#), for details.

To enter Hibernation mode, follow the steps below.

1. Click **start**.
2. Select **Turn off Computer**.
3. Open the **Turn off Computer** dialog box. If **Hibernate** is not displayed, go to step 4. If **Hibernate** is displayed, go to step 5.
4. Press the **Shift** key. The **Stand By** item will change to **Hibernate**.
5. Select **Hibernate**.

Automatic Hibernation

The computer will enter Hibernate mode automatically when you press the power button or close the lid. First, however, make the appropriate settings according to the steps below.

1. Open the **Control Panel**.
2. Open **Performance and Maintenance** and open **Power Options**.
3. Select the **Hibernate** tab.
4. Select **Enable Hibernation**, then click **OK** button.

Data save in hibernation mode

When you turn off the power in hibernation mode, the computer takes a moment to save current memory data to the hard disk. During this time, the **Built-in Hard Disk Drive** indicator will light.

After you turn off the computer and memory is saved to the hard disk, turn off the power to any peripheral devices.



Do not turn the computer or devices back on immediately. Wait a moment to let all capacitors fully discharge.

Standby mode

In standby mode the power remains on, but the CPU and all other devices are in Standby mode.



- *If the computer is not used or accessed in any way, including receipt of e-mail, for approximately 15 or 30 minutes when the AC adapter is connected, the computer will automatically enter Standby mode (Power Options default).*
- *To restore operation, press the power button.*
- *If the computer automatically enters Standby mode while a network application is active, the application might not be restored when the computer wakes up from Standby.*
- *To prevent the computer from automatically entering Standby mode, disable Standby in Power Options. That action, however, will nullify the computer's Energy Star compliance.*

Standby precautions

- Before entering Standby mode, be sure to save your data.
- Do not remove/install memory or remove power components:
 - Do not remove/install the memory module. The computer or the module could be damaged.
 - Do not remove the Battery Pack.

In any of the above cases, the standby configuration will not be saved.

- If you carry the computer on board an aircraft or into a hospital, be sure to shut down the computer in hibernation mode or in shutdown mode to avoid radio signal interference.

Benefits of Standby

The standby feature provides the following benefits:

- Restores the previous working environment more rapidly than does hibernation.
- Saves power by shutting down the system when the computer receives no input or hardware access for the duration set by the System Standby feature.
- You can use the panel power off feature.

Enabling Standby



You can also enable Standby by pressing **Fn + F3**. See Chapter 5, *The Keyboard*, for details.

You can enter standby mode in one of three ways:

1. Click **start**, click **Turn off Computer** and click **Stand By**.
2. Close the display panel. This feature must be enabled. Refer to the **Advanced** tab in **Power Options** described in the Control Panel.
3. Press the power button. This feature must be enabled. Refer to the **Advanced** tab in **Power Options** described in the Control Panel.

When you turn the power back on, you can continue where you left when you shut down the computer.



- *When the computer is shut down in standby mode, the power indicator glows amber.*
- *If you are operating the computer on battery power, you can lengthen the operating time by shutting down in hibernation mode. Standby mode consumes more power.*

Standby limitations

Standby will not function under the following conditions:

- Power is turned back on immediately after shutting down.
- Memory circuits are exposed to static electricity or electrical noise.

Restarting the computer

Certain conditions require that you reset the system. For example, if:

- You change certain computer settings.
- An error occurs and the computer does not respond to your keyboard commands.
- There are three ways to reset the computer system:
 1. Select **Restart** from the **Turn Off Computer** dialogue from StartMenu.
 2. Press **Ctrl + Alt + Del** to display Windows Task Manager, select **Restart** from the "Shut down" options.
 3. Press the power button and hold it down for five seconds. Once the computer has turned itself off, wait between ten and fifteen seconds before turning it on again with the power button.

Create Optical Recovery Discs (depends on the model you purchased)

A recovery image of your computer is stored on the hard disk. You may use this image to create CD or DVD recovery discs using the following steps:

1. Select either blank CDs or DVD media.
2. The application will allow you to choose a type of media to create recovery CDs/DVD including: CD-R, CD-RW, DVD-R, DVD-RW, DVD+R and DVD+RW.



Some media may not be compatible with the Optical Drive of your computer. Please verify your Optical Drive supports the blank media you choose.

3. Turn on your computer to open Windows XP.
4. Insert the (first) blank media into the tray of the Optical Drive.
5. Double Click the **Recovery Disc Creator** icon on the Windows XP desktop, or select the application from Start menu.
6. After TOSHIBA Recovery Disc Creator starts, select the type of media and the title you wish to copy to the media then click the **Create** button.



If your Optical Drive can only write to CDs, select "CD" as the "Disc Set" on TOSHIBA Recovery Disc Creator. If your Optical Drive of your computer can write to either CD or DVDs, select the one you are using as the "Disc Set" on TOSHIBA Recovery Disc Creator.

Restoring the preinstalled software from the Recovery HDD (depends on the model you purchased)

Part of the space on the hard disk drive is reserved as recovery partition for restoring the pre-installed software from the hard disk drive.

When re-setting up your hard disk, do not change, delete or add partitions in a manner other than specified in the manual. Otherwise, space for software may be destroyed.

In addition, if you use a third-party partitioning program to reconfigure partitions on your hard disk, it may become impossible to re-setup your computer.

1. Turn off your computer.
2. Hold down the 0 (zero) key on the keyboard and turn on your computer. When "In Touch with Tomorrow TOSHIBA" appears, release the 0 (zero) key on the keyboard.
3. A menu appears. Follow the on-screen instructions.



When you reinstall the Windows operating system, the hard disk will be reformatted and all data will be lost.

Restoring the preinstalled software from Recovery Media

If the preinstalled files are damaged, use the Recovery Media you created, or the Product Recovery Media, to restore them. To restore the operating system and all preinstalled software, follow the steps below.



When you reinstall the Windows operating system, the hard disk will be reformatted and all data will be lost.

1. Load the Recovery Media in the optional optical media drive and turn off the computer's power.
2. Hold down the **F12** key and turn on the power. When **In Touch with Tomorrow TOSHIBA** appears, release the **F12** key.
3. Use the upper or lower cursor key to select the CD/DVD in the display menu. For details, refer to the *Boot Priority* section in Chapter 7, *HW Setup*.
4. A menu appears. Follow the on-screen instructions.

Chapter 4

Operating Basics

This chapter gives information on basic operations including using the TouchPad, optical media drives, sound system, modem, the wireless LAN and LAN. It also provides tips on caring for your computer.

Using the TouchPad

To use the TouchPad, simply touch and move your finger tip across it in the direction you want the on-screen pointer to go.

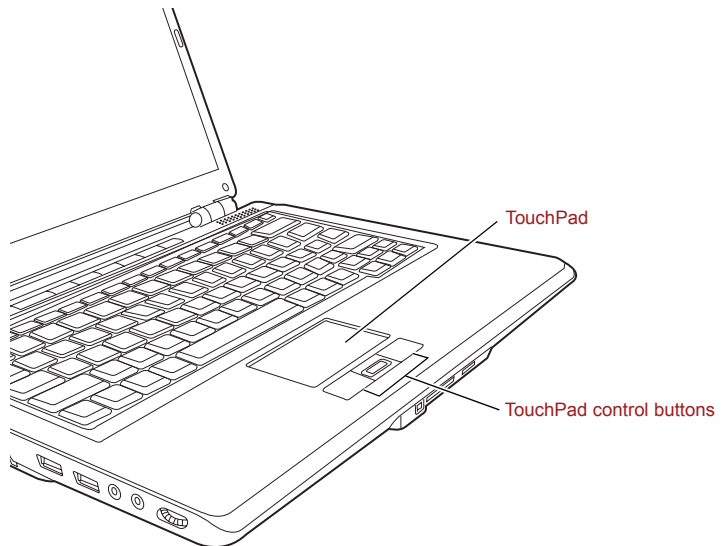

TouchPad and TouchPad control buttons

Two buttons below the keyboard are used like the buttons on a mouse pointer. Press the left button to select a menu item or to manipulate text or graphics designated by the pointer. Press the right button to display a menu or other function depending on the software you are using.



Do not press on the TouchPad too hard or press a sharp object such as a ball point pen against the TouchPad. The TouchPad could be damaged.

For some functions, you can tap the TouchPad instead of pressing a control button.



Click: Tap the TouchPad once

Double-click: Tap the TouchPad twice

Drag and drop:

1. Hold down the left control button and move the cursor to drag the item you want to move.
2. Lift your finger to drop the item where you want it.

Scroll:

Vertical: Move your finger up or down the right edge of the TouchPad.

Horizontal: Move your finger left or right along the bottom edge of the TouchPad.

Using the FingerPrint Reader (depends on model purchased)

This product has a FingerPrint utility installed for the purpose of enrolling and recognizing FingerPrints. By enrolling the ID and password to the FingerPrint authentication device, it is no longer necessary to input the password from the keyboard. Just by swiping the finger against the FingerPrint sensor, the following functions will be enabled:

- Log-on to Windows and access a security-enabled homepage through IE (Internet Explorer).
- Files and folders can be encrypted/decrypted and third party access to them prevented.
- Disable the password-protected screen-saver when returning from power-saving mode such as Standby Mode.
- Power-on Security and Single Sign-On feature.



To "swipe" refers to the action of reading a FingerPrint using the FingerPrint sensor.

How the Swipe the Finger

Using the following steps when swiping fingers for FingerPrint registration or authentication will help to minimize authentication failures:

1. Align the first joint of the finger to the center of the sensor. Lightly touch the sensor and swipe finger levelly towards you.

While lightly touching the sensor, swipe the finger towards you until the sensor surface becomes visible.

Ensure the center of the FingerPrint is on the sensor when swiping the finger.



- *Avoid swiping with the finger stiff or pressed-on too hard*
FingerPrint reading may fail if the center of the FingerPrint is not touching on the sensor, or when finger is swiped while pressing hard. Make sure that the center of the FingerPrint is touching the sensor before swiping.
- *Confirm the center of the FingerPrint whirl before swiping*
The thumb's FingerPrint has a bigger whirl, which is prone to misalignment and distortions. This will cause difficulty in registration and a drop in the authentication success rate. Always confirm the center of the FingerPrint whirl so that it is swiped along the centerline of the sensor.
- *When FingerPrint reading is not successful*
There is a possibility of authentication failures if the finger is swiped too quickly or too slowly. Follow the onscreen instructions to adjust the speed of the swipe.

The following illustrations show the correct way to slide your finger over the recognition sensor.

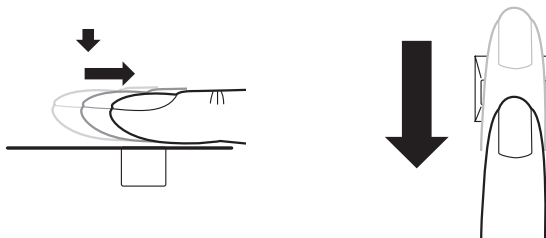

Align the finger and sensor like the drawings.

Points to note about the FingerPrint Sensor

Please be aware of the following considerations when using the FingerPrint sensor. A failure to follow these guidelines might result in damage to the sensor, sensor failure, FingerPrint recognition problems or a lower FingerPrint recognition success rate.

- Do not scratch or poke the sensor with your nails or any hard or sharp objects.
- Do not press the sensor strongly.
- Do not touch the sensor with a wet finger or any wet objects - keep sensor surface dry and free of water vapor.
- Do not touch the sensor with a soiled or dirty finger as minute foreign particles of dust and dirt may scratch it.
- Do not paste stickers or write on the sensor
- Do not touch the sensor with a finger or any other object which may have a built-up of up static electricity on it.

Observe the following before you place your finger on the sensor whether for FingerPrint enrollment/registration or recognition.

- Wash and dry your hands thoroughly.
- Remove static electricity from your fingers by touching any metal surface. Static electricity is a common cause of sensor failures, especially when the weather is dry.
- Clean the sensor with a lint-free cloth - do not use detergent to any other chemicals to clean the sensor.
- Avoid the following finger conditions for enrollment or recognition as they may result in FingerPrint enrollment errors or a drop in the FingerPrint recognition success rate.
 - Soaked or swollen finger (e.g. after taking bath)
 - Injured finger
 - Wet finger
 - Soiled or oily finger
 - Extremely dry skin condition on finger

Observe the following to improve the FingerPrint recognition success rate.

- Enroll two or more fingers.
- Enroll additional fingers if recognition failure occurs when using already enrolled fingers.
- Check the condition of your finger - any conditions which have changed since enrollment, such as injured, rough, extremely dry, wet, soiled, dirty, oily, soaked, swollen fingers, may lower the recognition success rate. Also if the FingerPrint is worn down or the finger becomes thinner or fatter, the recognition success rate may be lowered.

- As the FingerPrint for each finger is different and unique, you should ensure that only the registered or enrolled FingerPrint or FingerPrints are used for identification.
- Check the position and speed at which you swipe your finger across the sensor - please refer to the preceding drawing.

How to Delete the FingerPrint Data

Saved FingerPrint Data is stored in special non-volatile memory inside the FingerPrint sensor. Therefore, if you give the computer to someone else, or dispose of it in any way, the following process is recommended to delete your FingerPrint information:

1. Click **start** followed by **All Programs**, followed by **Protector Suite QL** and then click **Control Center**.
2. The **Fingerprint Control Center** screen is displayed.
3. Click **FingerPrints** and click **Delete**.
4. Click **Settings** and click **Fingerprint Storage Inspector**.
5. The **Fingerprint Storage Inspector** screen will be displayed. If FingerPrint data is displayed as part of the list, simply select all of this information and then **Remove**.
6. Check whether all of the FingerPrint data was deleted on the **Fingerprint Storage Inspector** screen.

In use, please be aware of the following limitations of the FingerPrint sensor:

- The FingerPrint sensor compares and analyzes the unique characteristics in a FingerPrint.
- A warning message will be displayed when recognition is abnormal or recognition is not successful within a fixed duration.
- The recognition success rate may differ from user to user.
- TOSHIBA does not guarantee that this FingerPrint recognition technology will be error-free.
- TOSHIBA does not guarantee that the FingerPrint sensor will recognize the enrolled user or accurately screen out unauthorized users at all times. TOSHIBA is not liable for any failure or damage that might arise out of the use of this FingerPrint recognition software or utility.

Points to note about the FingerPrint Utility software



You are able to backup saved FingerPrint data and information within the PasswordBank by using the import or Export User Data facility under the FingerPrint management software. However, please be aware that any encrypted files cannot be backup within FileSafe using this function - in these instances it is recommended that you backup these files to external media using standard file copy processes.

The user should back up the user profile information when using the functions provided in this software to encrypt files or folders. If this software or the user information is deleted without backing up the user profile information, the encrypted files will no longer be accessible. In addition, if the backup data is not used, the user will not be identified as the same user even if the same name is used again in user enrolment.

Please refer to the following procedures to back up.

If Windows XP's file encryption function EFS (Encryption File System) is used to encrypt a file, the file cannot be further encrypted using the encryption function of this software. In the help file, it is stated that this software's Password Bank function can be used for the Internet and general applications. However, the Internet Password Bank function in the FingerPrint utility provided in this computer can only be used with IE (Internet Explorer).

Set up Procedure

Please use the following procedure when first using Fingerprint authentication.

FingerPrint Registration

You should initially enroll the required authentication data using the 'User Enrollment' Wizard.



- *In use, the FingerPrint authentication system will use the same username and password as defined within Windows operating system. If no Windows password has been configured, you must do this before starting the FingerPrint registration process.*
- *Up to twenty-one FingerPrint patterns can be registered on this sensor.*

1. Click **start** followed by **All Programs** followed by **Protector Suite QL** and then click **User Enrollment**.



You are also able to start the User Enrollment Wizard by using the following method.

- *Click the Protector Suite QL icon in the Task Bar.*
- *Swipe your finger across the FingerPrint Sensor.*

2. Click **Next**.

3. At the **User's Password** screen which is then displayed, you should ensure that the same Windows username is displayed before entering the appropriate password into the **Enter password** field. Once this has been done, click **Next**.
4. At the **Hints for Fingerprint Enrollment** screen, confirm the message displayed and ensure that there is a check mark in the **Run interactive tutorial** box. Once this has been done, click **Next**.
5. At the **Correct Swipe Procedure** screen, confirm the message that is displayed and then click **Next**.
6. At the **Scanning Practice** screen, you are able to practice swiping your finger to ensure you use the correct method. Once you have finished practicing, click **Next**.
7. At the **User's Fingers** screen, select the finger you wish to enroll from the illustration and then click **Next**. On this screen please be aware that any previously enrolled FingerPrints would have green check marks, while the FingerPrint you are about to enroll will have a red check mark. If any of the previously enrolled FingerPrints is selected again, the latest information will be enrolled and any previous information over-written.
8. At **Advanced Security** screen, select whether you wish to enable the security function, and then click **Next**.
9. At **Finalization** screen, click **Finish** - this will complete the FingerPrint registration process.

Window Log-on via FingerPrint Authentication

If required, you are also able to use FingerPrint authentication in place of the usual Windows log-on process using your username and password. This method is specially useful where there are many users using the same computer as it removes the need for actual user selection when the system is started.

FingerPrint Authentication Procedure

1. Start up the computer.
2. At the **Log-on Authorization** screen, choose any of the enrolled fingers and swipe the FingerPrint on the sensor - If the authentication process is successful, the user will automatically be logged into Windows.



If the FingerPrint authentication process fails you will need to log into Windows using the appropriate username and password. In addition, you should use this manual login process if Finger Print authentication fails for three consecutive tries - a warning message will be displayed when authentication is not normal or is not successful within a fixed duration.

FingerPrint Power-on Security

General

The FingerPrint authentication system can be used to replace the keyboard based password authentication system that is used when the computer is turned on.

If you do not want to use the FingerPrint authentication system for password authentication when the computer is turned on, but instead prefer to use the keyboard entry method instead, simply press the **BKSP** (backspace) key or the ESC/Rotation button when the FingerPrint Power-on Security screen is displayed. Using this process will switch the password input screen across to the keyboard based entry screen.



- *You must ensure that you use the TOSHIBA Password Utility to register a User Password before using the FingerPrint Power-on Security and its extended function to allow FingerPrint to be used to access the computer when it is turned on.*
- *If the FingerPrint authentication process fails five times, a preset time limit is exceeded, or you press the BkSP (backspace) key, [Password=] will be displayed on the screen and you will have to enter either the User Password or Supervisor Password manually in order to start the computer.*
- *When swipe your finger, please ensure you do it slowly and at a constant speed. If you find that this does not improve the authentication rate, you should try to adjust the speed at which the finger is swiped.*
- *If there are any changes in the environment or setting related to authorization, you will be required to provide authorization information such as a User Password (and, if applicable, the HDD (Hard Disk Drive) password).*

How to Enable FingerPrint Power-on Security Settings

It is necessary to first enroll your FingerPrint with the Protector Suite QL application prior to enabling and configuring the FingerPrint Power-on Security System. You should check that your FingerPrint is enrolled before configuring the settings (please refer to the Manual for FingerPrint Registration/Enrollment for further instructions.)

1. Swipe your finger across the FingerPrint Sensor.
2. **MENU** will appear in the place where your mouse is. Swipe(*) your finger on the FingerPrint sensor and then select **Control Center** from the items presented in this menu.

(*) It is recommended that the keyboard cursor keys (movement) and enter key (selection) or the directional pad be used when selecting and item from the Menu in laptop or landscape modes.

3. At the **Fingerprint Control Center** screen, click **Settings** and then click **System Settings**.
4. At the **Protector Suite Settings** screen, place a check mark in the Allow power-on security single sign-on and then click **OK**.

FingerPrint Single Sign-On Feature

General

This is a feature that allows the user to complete the authentication for both the User/BIOS Password (and, if applicable, the HDD (Hard Disk Drive) Password) and logging onto Windows using only one *FingerPrint* authentication when booting up. It is necessary to register the User/BIOS Password and Windows Log-on password before using the *FingerPrint* Power-on Security and this FingerPrint Single Sign On Feature. Please use TOSHIBA Password Utility to register your User/BIOS Password. If Windows Log-on is not the default for your system, see Manual to register your Windows Log-on password.

Only one FingerPrint authentication is required to replace the User/BIOS Password (and, if applicable, the HDD (Hard Disk Drive) Password) and Windows Log-on Password.

How to Enable FingerPrint Single Sign-On Feature

It is necessary to first enroll your FingerPrint with the Protector Suite QL application prior to enabling and configuring the FingerPrint **Single Sign-On Feature**. You should check that your *FingerPrint* is enrolled before configuring the settings (please refer to the Manual for FingerPrint Registration/Enrollment for further instructions).

1. Swipe your finger across the FingerPrint Sensor.
2. **MENU** will appear in the place where your mouse is. Swipe(*) your finger on the *FingerPrint* Sensor and select **Control Center** from the items presented in this menu.

(*) It is recommended that the keyboard cursor keys (movement) and enter key (selection) or the directional pad be used when selecting an item from the Menu in laptop or landscape modes.

3. At the **Fingerprint Control Center** screen, click **Settings** and then click **System Settings**.
4. At the **Protector Suite Settings** screen, place a check mark in the Allow power-on security single sign-on and then click **OK**.

FingerPrint utility limitations

TOSHIBA does not guarantee that the FingerPrint utility technology will be completely secure or error-free or it will be accurately screen out unauthorized users at all times. TOSHIBA is not liable for any failure or damage that might arise out of the use of the FingerPrint software.

Using the Web Camera (depends on the model purchased)

This section describes the bundled webcam utility, which can capture still and video images. The web camera will auto-run when Windows starts.

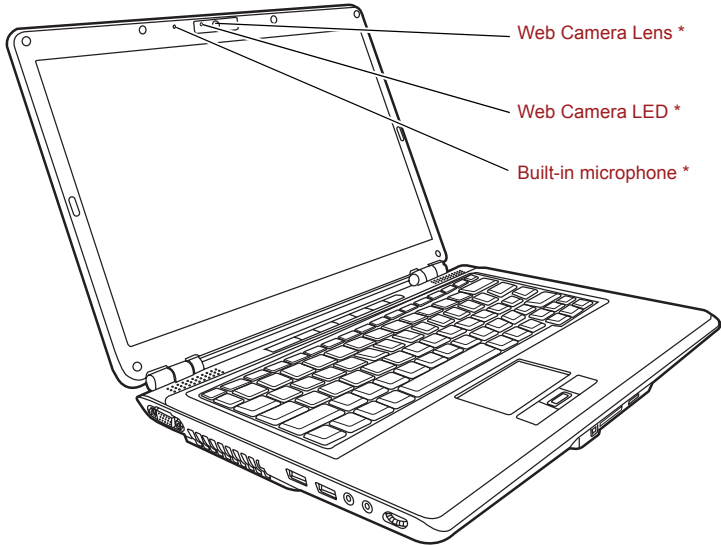

* Depends on the model purchased

Using the software

The web camera software is pre-configured to start when you turn on Windows XP; if you need to restart it go to **start** → **All Programs** → **Camera Assistant Software** → **Camera Assistant Software**.

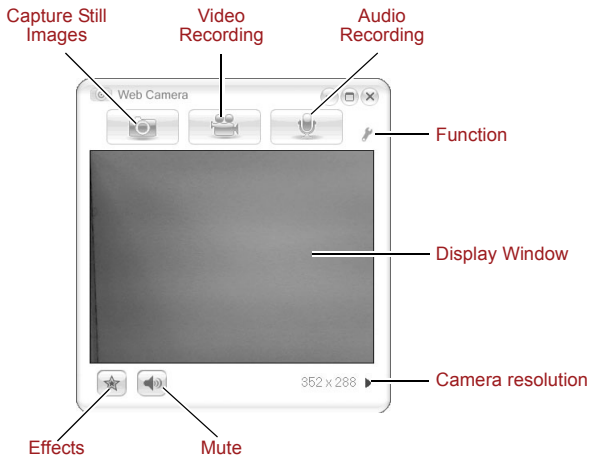

Capture Still Images	Click to see a preview of the captured image; you can also e-mail the image.
Video Recording	Click to prepare for recording. Click again to start recording. One more to stop recording and see preview of the video.
Audio Recording	Click to start recording, click again to stop and listen to a preview of the audio.
Function	Access additional functions: About, Player, Effects, Properties, Settings and Help.
About	Displays software manufacturer details.
Player	Play video files.
Effects	Choose images to be displayed on the capture screen.
Properties	Choose from the Options tab to flip, zoom, flicker rate, night mode and backlight compensation; in the Image tab change the color settings; in the Profiles tab change the lighting conditions.
Settings	Choose from the: Options tab to change the tool bar position; the Picture tab to select picture output options such as size, export file and save path; the Video tab to choose video output settings such as Frame Rate, Size, Compression and the frame rate, size, record compressor, and save path; the Audio tab to change the audio device, audio compressor, audio volume and save path.
Help	Displays the help files for the software.

Using the microphone

Your computer has a built-in microphone that can be used to record monaural sounds into your applications. It can also be used to issue voice commands to applications that support such functions. (Built-in microphone is provided with some models)

Since your computer has a built-in microphone and speaker, “feedback” may be heard under certain conditions. Feedback occurs when sound from the speaker is picked up in the microphone and amplified back to the speaker, which amplifies it again to the microphone.

This feedback occurs repeatedly and causes a very loud, high-pitched noise. It is a common phenomenon that occurs in any sound system when the microphone input is output to the speaker (throughput) and the speaker volume is too loud or too close to the microphone. You can control throughput by adjusting the volume of your speaker or through the Mute function in the Master Volume panel. Refer to your Windows documentation for details on using the Master Volume panel.

Using the optical media drive

The text and illustrations in this section refer primarily to the optical CD-ROM drive. However, operation is the same for all other optical media drives. The full-size drive provides high-performance execution of CD-ROM-based programs. You can run either 12 cm (4.72") or 8 cm (3.15") CDs without an adaptor. An ATAPI interface controller is used for CD-ROM operation. When the computer is accessing a CD-ROM, an indicator on the drive glows.

If you have a DVD Super Multi drive, refer also to the [Writing CD/DVDs with the DVD Super Multi drive supporting DVD±R Double layer](#) section for precautions on writing to CDs/DVDs.

Loading discs

To load a disc, follow the steps below and refer to the figures.

1. a. When the power is on, press the eject button to open the drawer slightly.

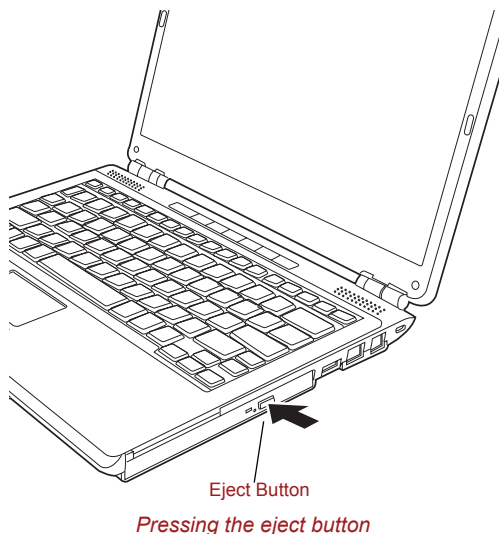

- b. Pressing the eject button will not open the drawer when the disc drive's power is off. If the power is off, you can open the drawer by inserting a slender object (about 15 mm) such as a straightened paper clip into the eject hole just to the right of the eject button.

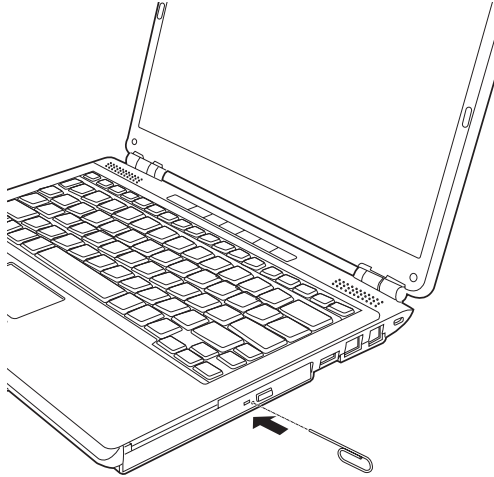

Manual release with the eject hole

2. Grasp the drawer gently and pull until it is fully opened.

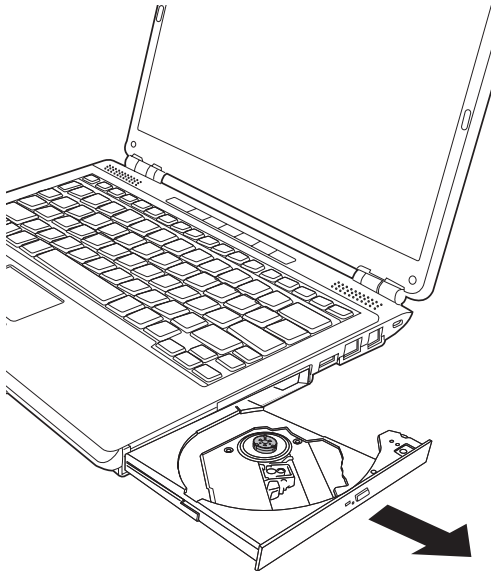

Pulling the drawer open

3. Place the disc, label side up, in the drawer.

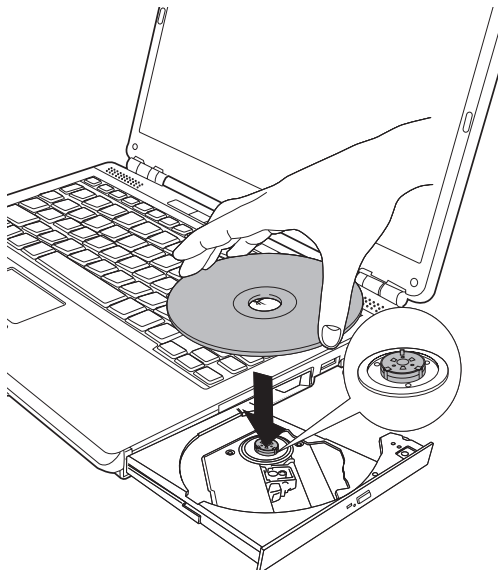

Inserting a disc



When the drawer is fully opened, the edge of the computer will extend slightly over the disc tray. Therefore, you will need to turn the disc at an angle when you place it in the tray. After seating the disc, however, make sure it lies flat, as shown in the figure above.



- *Do not touch the laser lens. Doing so could cause misalignment.*
- *Keep foreign matter from entering the drive. Check the back edge of the tray to make sure it carries no debris before closing the drive.*

4. Press gently at the centre of the disc until you feel it click into place. The disc should lie below the top of the spindle, flush with the spindle base.
5. Push the center of the drawer to close it. Press gently until it locks into place.



If the disc is not seated properly when the drawer is closed, the disc might be damaged. Also, the drawer might not open fully when you press the eject button.

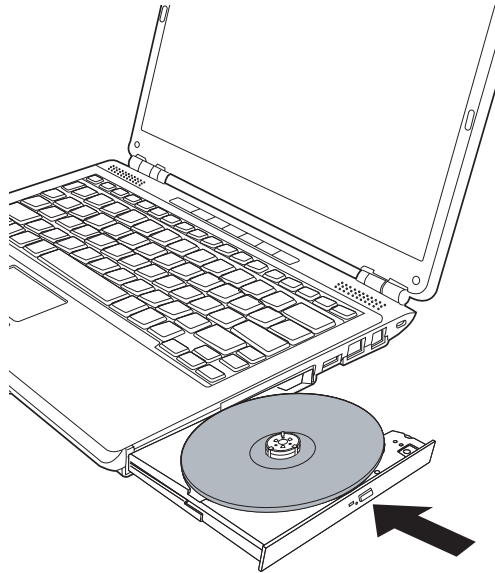

Closing the disc drawer

Removing discs

To remove the disc, follow the steps below and refer to the figure.



Do not press the eject button while the computer is accessing the disc drive. Wait for the optical media drive indicator to go out before you open the drawer. Also, if the disc is spinning when you open the drawer, wait for it to stop before you remove it.

1. To pop the drawer partially open, press the eject button. Gently pull the drawer out until it is fully opened.



- *When the drawer pops open slightly, wait a moment to make sure the disc has stopped spinning before pulling the drawer fully open.*
- *Turn off the power before you use the eject hole. If the disc is spinning when you open the drawer, the disc could fly off the spindle and cause injury.*

2. The disc extends slightly over the sides of the drawer so you can hold it. Hold the disc gently by its edges and lift it out.

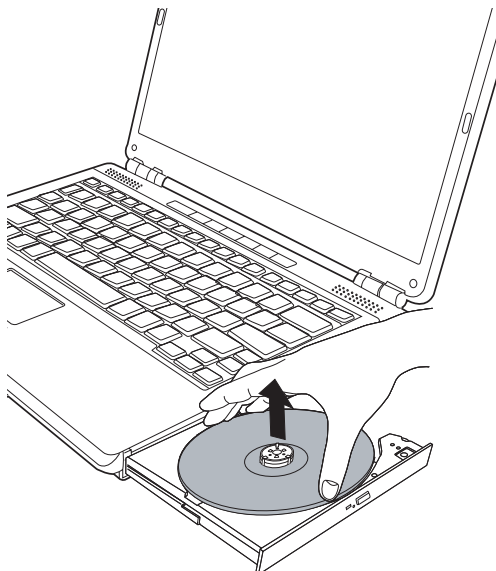

Removing a disc

3. Push the centre of the drawer to close it. Press gently until it locks into place.

Writing CD/DVDs with the DVD Super Multi drive supporting DVD±R Double layer



Some models in this series are equipped with Writing CD/DVDs with the DVD Super Multi drive (Supporting DVD±R Double Layer).

You can use the DVD Super Multi drive to write data to either CD-R/RW or DVD-R/-RW/+R/+RW/-RAM discs. The following applications for writing are preinstalled: TOSHIBA Disc Creator and TOSHIBA Direct Disc Writer.

Important message (DVD Super Multi drive supporting DVD±R Double layer)

Before you write or rewrite to CD-R/RW or DVD-R/-RW/+R/+RW/-RAM discs, read and follow all setup and operating instructions in this section. If you fail to do so, the DVD Super Multi drive may not function properly, and you may fail to write or rewrite, lose data or incur other damage.

Before writing or rewriting

- Based on TOSHIBA's limited compatibility testing, we suggest the following manufacturers of CD-R/RW and DVD-R/+R/-RW/+RW/-RAM discs. However, in no event does TOSHIBA guarantee the operation, quality or performance of any disc. Disc quality can affect write or rewrite success rates.

CD-R: TAIYO YUDEN Co., Ltd.
MITSUBISHI KAGAKU MEDIA CO, LTD.
Ricoh Co., Ltd.
Hitachi Maxell Ltd.

CD-RW: MITSUBISHI KAGAKU MEDIA CO, LTD.
Ricoh Co., Ltd.

High Speed CD-RW: MITSUBISHI KAGAKU MEDIA CO, LTD.
Ricoh Co., Ltd.

Ultra Speed CD-RW: MITSUBISHI KAGAKU MEDIA CO, LTD.

DVD-R: **DVD Specifications for Recordable disc for General Version2.0**
TAIYO YUDEN Co., Ltd.
Matsushita Electric Industrial Co., Ltd.

DVD-R(DL): MITSUBISHI KAGAKU MEDIA CO, LTD.

DVD+R: MITSUBISHI KAGAKU MEDIA CO, LTD.
Ricoh Co., Ltd.

DVD+R(DL): MITSUBISHI KAGAKU MEDIA CO, LTD.

DVD-RW: **DVD Specifications for Recordable Disc for Version 1.1 or 1.2**
Victor Company of Japan, Ltd. (JVC)
MITSUBISHI KAGAKU MEDIA CO, LTD.

DVD+RW: MITSUBISHI KAGAKU MEDIA CO, LTD.

DVD-RAM: DVD Specifications for DVD-RAM Disc for Version2.0, 2.1 or 2.2
Hitachi Maxell Ltd.
Matsushita Electric Industrial Co., Ltd.



This drive cannot use discs that allow writing of 8 speeds or more (DVD-R, DVD+R, DVD+RW), or 6 speeds or more (DVD-RW)

- If the disc is poor in quality, dirty or damaged, writing or rewriting errors may occur. Be careful to check the disc for dirt or damage before you use it.
- The actual number of rewrites to CD-RW, DVD-RW, DVD+RW or DVD-RAM is affected by the quality of the disc and the way it is used.

- There are two types of DVD-R discs: authoring and general use discs. Do not use authoring discs. Only general use discs can be written to by a computer drive.
- We can support only Format1 of DVD-R DL. Therefore you cannot do the additional writing. If your data is under 4.7GB, we suggest to use DVD-R (SL) media.
- You can use DVD-RAM discs that can be removed from a cartridge and DVD-RAM discs designed without a cartridge. You can not use a disc with a 2.6GB single-sided capacity and 5.2GB double-sided capacity.
- Other DVD-ROM drives for computers or other DVD players may not be able to read DVD-R/-RW or DVD+R/+RW discs.
- Data written to a CD-R/DVD-R/DVD+R disc cannot be deleted either in whole or in part.
- Data deleted (erased) from a CD-RW, DVD-RW, DVD+RW and DVD-RAM disc cannot be recovered. Check the content of the disc carefully before you delete it. If multiple drives that can write data to discs are connected, be careful not to delete data from the wrong drive.
- In writing to a DVD-R/-RW, DVD+R/+RW or DVD-RAM disc, some disc space is required for file management, so you may not be able to write the full capacity of the disc.
- Since the disc is based on the DVD standard, it might be filled with dummy data if the written data is less than about 1 GB. Even if you write only a small amount of data, it might take time to fill in the dummy data.
- DVD-RAM formatted by FAT32 cannot be read in Windows® 2000 without DVD-RAM Driver Software.
- When multiple drives that can write data to discs are connected, be careful not to write to the wrong drive.
- Be sure to connect the AC adaptor before you write or rewrite.
- Before you enter Standby Mode/Hibernation Mode, be sure to finish DVD-RAM writing. Writing is finished if you can eject DVD-RAM media.
- Be sure to close all other software programs except the writing software.
- Do not run software such as a screen saver, which can put a heavy load on the CPU.
- Operate the computer under the power scheme **High Performance**. Do not use power-saving features.
- Do not write while virus check software is running. Wait for it to finish and then disable virus detection programs including any software that checks files automatically in the background.
- Do not use hard disc utilities, including those intended to enhance HDD access speed. They may cause unstable operation and data damage.
- Write from the computer's hard disc drive to the CD/DVD. Do not try to write from shared devices such as a LAN server or any other network device.
- Writing with software other than TOSHIBA Disc Creator is not recommended.

When writing or rewriting

Please observe/consider the following when you write or rewrite to a CD-R/-RW, DVD-R/-RW/-RAM or DVD+R/+RW disc.

- Do not perform any of the following actions when writing or rewriting:
 - Change users in the Windows® XP operating system.
 - Operate the computer for any other function, including using a mouse or TouchPad or closing/opening the LCD panel.
 - Start a communication application such as a modem.
 - Apply impact or vibration to the computer.
 - Install, remove or connect external devices, including the following: PC Card, USB devices, external display, optical digital devices.
 - Use the audio/video control buttons to reproduce music or voice.
 - Open the DVD Super Multi drive.
- Do not use shut down/log off and Standby Mode/Hibernation Mode while writing or rewriting.
- Make sure writing or rewriting is completed before going into Standby Mode/Hibernation Mode. Writing is completed if you can open the DVD Super Multi drive tray.
- Set the computer on a level surface and avoid places subject to vibration such as airplanes, trains, or cars. Do not use an unstable surface such as a stand.
- Keep mobile phones and other wireless communication devices away from the computer.
- Always copy data from the hard disk drive to the CD-R/-RW, DVD-R/-RW/-RAM or DVD+R/+RW disc. Do not use cut-and-paste. The original data will be lost if there is a write error.

Disclaimer (DVD Super Multi drive supporting DVD±R Double layer)

TOSHIBA does not bear responsibility for the following:

- Damage to any CD-R/RW or DVD-R/-RW/+R/+RW/-RAM disc that may be caused by writing or rewriting with this product.
- Any change or loss of the recorded contents of CD-R/RW or DVD-R/-RW/+R/+RW/-RAM disc that may be caused by writing or rewriting with this product, or for any business profit loss or business interruption that may be caused by the change or loss of the recorded contents.
- Damage that may be caused by using third party equipment or software. Given the technological limitations of current optical disc writing drives, you may experience unexpected writing or rewriting errors due to disc quality or problems with hardware devices. Also, it is a good idea to make two or more copies of important data, in case of undesired change or loss of the recorded contents.

TOSHIBA Disc Creator

Note the following limitations when you use TOSHIBA Disc Creator:

- DVD-Video cannot be created using TOSHIBA Disc Creator.
- DVD-Audio cannot be created using TOSHIBA Disc Creator.
- You cannot use the TOSHIBA Disc Creator "Audio CD" function to record music to the DVD-R/-RW or DVD+R/+RW media.
- Do not use the "Disc Backup" function of TOSHIBA Disc Creator to copy
- DVD-Video and DVD-ROM with copyright protection. DVD-RAM media cannot be backed up with the "Disc Backup" function of TOSHIBA Disc Creator.
- You cannot back up a CD-ROM or CD-R/RW to DVD-R/-RW or DVD+R/+RW using the "Disc Backup" function of TOSHIBA Disc Creator.
- You cannot back up DVD-ROM, DVD-Video or DVD-R/-RW or DVD+R/+RW to CD-R/RW using TOSHIBA Disc Creator.
- TOSHIBA Disc Creator cannot record in packet format.
- You might not be able to use the Disc Backup function of TOSHIBA Disc Creator to backup a DVD-R/-RW or DVD+R/+RW disc that was made with other software on a different DVD-R/-RW or DVD+R/+RW recorder.
- If you add data to a DVD-R and DVD+R disc that you have already recorded to, you might not be able to read the added data under some circumstances. It cannot be read in 16-bit operating systems, such as Windows 98SE and Windows ME, in Windows NT4 you will need Service Pack 6 or later to read the data, and in Windows 2000 you will need Service Pack 2 or later to read it. Some optical media drives cannot read added data regardless of the operating system.
- TOSHIBA Disc Creator does not support recording to DVD-RAM discs. To record to a DVD-RAM, use Explorer or other similar utility.
- When you back up a DVD disc, be sure the source drive supports recording to DVD-R/-RW or DVD+R/+RW discs. If the source drive does not support recording to DVD-R/-RW or DVD+R/+RW discs, it might not be backed up correctly.
- When you back up a DVD-R, DVD-RW, DVD+R or DVD+RW, be sure to use the same type of disc.
- You cannot partially delete any data written to a CD-RW, DVD-RW or DVD+RW disc.

Data Verification

To verify that data is written or rewritten correctly, follow the steps below before you write or rewrite a Data CD/DVD.

1. Display the setting dialog box by one of the following two steps:
 - Click the setting button () for writing on the main toolbar in the **Data Disc** mode.
 - In the **Settings** menu, select **Settings for Each Mode**, then **Data Disc**.
2. Mark the **Verify Written Data** check box.
3. Select **File Open** or **Full Compare** mode.
4. Click the OK button.

Media care

This section provides tips on protecting data stored on your CD/DVDs.

Handle your media with care. The following simple precautions will increase the lifetime of your media and protect the data stored on them:

CD/DVDs

1. Store your CD/DVDs in the container they came in to protect them and keep them clean.
2. Do not bend the CD/DVD.
3. Do not write on, apply a sticker to, or otherwise mar the surface of the CD/DVD that contains data.
4. Hold the CD/DVD by its outside edge or the edge on the centre hole. Fingerprints on the surface can prevent the drive from properly reading data.
5. Do not expose to direct sunlight, extreme heat or cold. Do not place heavy objects on your CD/DVDs.
6. If your CD/DVDs become dusty or dirty, wipe them with a clean dry cloth. Wipe from the centre out, do not wipe in a circular direction around the CD/DVD. If necessary, use a cloth dampened in water or a neutral cleaner. Do not use benzene, thinner or similar cleaner.

Modem (depends on the model purchased)

This section describes how to connect and disconnect the internal modem to and from a telephone jack.



The internal modem does not support voice functions. All data and fax functions are supported.



- *In case of a lightning storm, unplug the modem cable from the telephone jack.*
- *Do not connect the modem to a digital telephone line. A digital line will damage the modem.*

Region selection

Telecommunication regulations vary from one region to another, so you will need to make sure the internal modem's settings are correct for the region in which it will be used.

To select a region, follow the steps below.

1. Click **start**, point to **All Programs**, **TOSHIBA**, **Networking**, and click **Modem Region Select**.



Do not use the Country/Region Select function in the Modem setup utility in the Control Panel if the function is available. If you change the Country/Region in the Control Panel, the change may not take effect.

2. The Region Selection icon will appear in the Task Bar. Click the icon with the primary mouse button to display a list of regions that the modem supports. A sub menu for telephony location information will also be displayed. A check will appear next to the currently selected region and telephony location.
3. Select a region from the region menu or a telephony location from the sub-menu.
 - When you click a region it becomes the modem's region selection, and the New Location for telephony will be set automatically.
 - When you select a telephony location, the corresponding region is automatically selected and it becomes the modem's current region setting.

Properties menu

Click the icon with the secondary mouse button to display properties menu on the screen.

Settings

You can enable or disable the following settings:

AutoRun Mode

The Region Select utility starts automatically when you start up the operating system.

Open the Dialling Properties dialog box after selecting region.

The dialing properties dialog box will be displayed automatically after you select the region.

Location list for region selection.

A submenu appears displaying location information for telephony.

Open dialog box, if the modem and Telephony Current Location region code do not match.

A warning dialog box is displayed if current settings for region code and telephony location are incorrect.

Modem Selection

If the computer cannot recognize the internal modem, a dialog box is displayed. Select the COM port for your modem to use.

Dialing Properties

Select this item to display the dialing properties.



If you are using the computer in Japan, the Telecommunications Business Law requires that you select Japan region mode. It is illegal to use the modem in Japan with any other selection.

Connecting

To connect the modem cable, follow the steps below.



- *The modular cable that comes with the computer must be used to connect a modem. Connect the end of the modular cable with the core to the computer.*
- *In case of a lightning storm, unplug the modem cable from the telephone jack.*
- *Do not connect the modem to a digital telephone line. A digital line will damage the modem.*

1. Plug one end of the modular cable into the modem jack.
2. Plug the other end of the modular cable into a telephone jack.

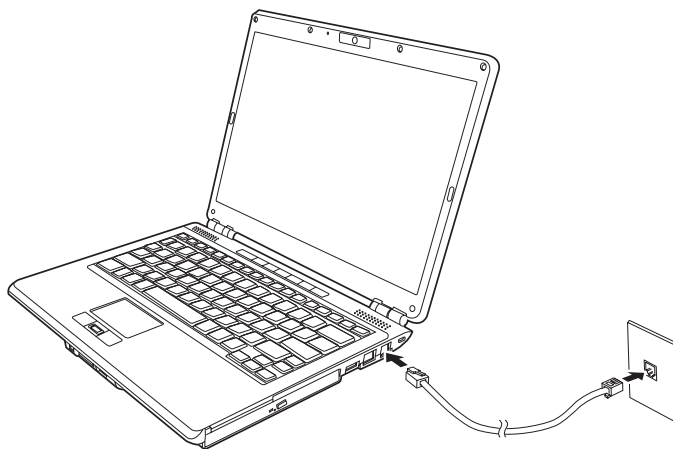

Connecting the internal modem



Do not pull on the cable or move the computer while the cable is connected.



If you use a storage device such as an optical drive or hard disk drive connected to a 16-bit PC Card, you might experience the following modem problems:

- *Modem speed is slow or communication is interrupted.*
- *Skips may occur in sound.*

Disconnecting

To disconnect the internal modem cable, follow the steps below.

1. Pinch the lever on the connector in the telephone jack and pull out the connector.
2. In the same way, pull the cable's other connector out of the computer.

Wireless communications

The computer's wireless communication function supports both Wireless LAN and Bluetooth devices.

Only some models are equipped with both Wireless LAN and Bluetooth functions.



- *Do not use the Wireless LAN (Wi-Fi) or Bluetooth functionalities near a microwave oven or in areas subject to radio interference or magnetic fields. Interference from a microwave oven or other source can disrupt Wi-Fi or Bluetooth operation.*
- *Turn Wi-Fi and Bluetooth functionalities off when near a person who may have a cardiac pacemaker implant or other medical electric device. Radio waves may affect pacemaker or medical device operation, possibly resulting in serious injury. Follow the instruction of your medical device when using any Wi-Fi or Bluetooth functionality.*
- *Always turn off Wi-Fi or Bluetooth functionality if the computer is near automatic control equipment or appliances such as automatic doors or fire detectors. Radio waves can cause malfunction of such equipment, possibly resulting in serious injury.*
- *It may not be possible to make a network connection to a specified network name using the ad hoc network function. If this occurs, the new network(*) will have to be configured for all computers connected to the same network in order to re-enable network connections.*
* Please be sure to use new network name.

Wireless LAN

The Wireless LAN feature is not available on all models. Where present, it supports the A, B, G and N standards but it is compatible with other LAN systems based on Direct Sequence Spread Spectrum/Orthogonal Frequency Division Multiplexing radio technology that complies with IEEE802.11 Wireless LAN standard.

- Automatic Transmit Rate Select mechanism in the transmit range of 54, 48, 36, 24, 18, 12, 9 and 6 Mbit/s. (IEEE 802.11g)
- Automatic Transmit Rate Select mechanism in the transmit range of 11, 5.5, 2 and 1 Mbit/s. (IEEE 802.11b)
- Roaming over multiple channels
- Card Power Management
- Wired Equivalent Privacy (WEP) data encryption, based on the 128 bit encryption algorithm.
- Advanced Encryption Standard (AES) data encryption, based on 128 bit encryption algorithm.



Wake-up on LAN does not function on a Wireless LAN.

Security

- Be sure to enable the encryption function otherwise you may expose your computer to illegal access by an outsider across the Wireless LAN which may cause intrusion, eavesdropping, and the loss or destruction of stored data. TOSHIBA strongly recommend the customer to enable the encryption function.
- TOSHIBA is not liable for the eavesdropping of data due to the use of Wireless LAN and the damage thereof.

Bluetooth® Stack for Windows® by TOSHIBA (depends on the model purchased)

Please note that this software is specifically designed for the following operating systems:

- Microsoft® Windows XP
Detailed information regarding the use with these operating systems is listed below. Please refer also to the electronic information which is included with each software.



This Bluetooth® Stack is based on Bluetooth® Version 1.1/1.2/2.0+EDR specification. TOSHIBA cannot confirm compatibility between any PC products and/or other electronic devices that use Bluetooth® other than TOSHIBA notebook computers.

Release Notes related to the Bluetooth® Stack for Windows® by TOSHIBA

1. Fax application software:
Regarding FAX application software, there are some software that you cannot use on this Bluetooth® Stack.
2. Multi User:
On Windows XP, the use of Bluetooth is not supported in a multi-user environment. This means that, when you use Bluetooth, other users logged onto the same computer will not be able to use its Bluetooth functionality.

Product Support:

The latest information regarding Operating System support, Language Support or available upgrades can be found on our web site <http://www.toshiba-europe.com/computers/tnt/bluetooth.htm> in Europe or www.pcsupport.toshiba.com in the United States.

Wireless communication switch

You can enable or disable the Wireless LAN function, with the on/off switch. No transmissions are sent or received when the switch is off. Slid the Switch to turn it on and turn it off.



Set the switch to off in airplanes and hospitals. Check the indicator. It will stop glowing when the wireless communication function is off.

Wireless communication indicator

The wireless communication indicator indicates the status of the wireless communication functions.

Indicator status	Indication
Indicator off	Wireless communication switch is set to off. Automatic power down because of overheating. Power malfunction
Indicator glows	Wireless communication switch is on. Wireless LAN is turned on by an application.

If you used the Task Bar to disable Wireless LAN, you will need to restart the computer to re-enable it. Alternatively, you can also follow this procedure:

1. In the **Control Panel**, click **Performance and Maintenance**, then **System**.
2. Select the **Hardware** tab.
3. Click the **Device Manager**. The Device Manager window opens. Click **Network adaptors**.
4. Select your preferred Network adaptor, then click the Enable button in the tool bar.

LAN

The computer has built-in support for Ethernet LAN (10 megabits per second, 10BASE-T) and Fast Ethernet LAN (100 megabits per second, 100BASE-TX). This section describes how to connect/disconnect to a LAN.

LAN cable types



The computer must be configured properly before connecting to a LAN. Logging onto a LAN using the computer's default settings could cause a malfunction in LAN operation. Check with your LAN administrator regarding set-up procedures.

If you are using Fast Ethernet LAN (100 megabits per second, 100BASE-TX), be sure to connect with a CAT5 cable or higher. You cannot use a CAT3 cable.

If you are using Ethernet LAN (10 megabits per second, 10BASE-T), you can connect with a CAT3 cable or higher.

Connecting LAN cable

To connect the LAN cable, follow the steps below.

1. Turn off the power to the computer and to all external devices connected to the computer.
2. Plug one end of the cable into the LAN jack. Press gently until you hear the latch click into place.

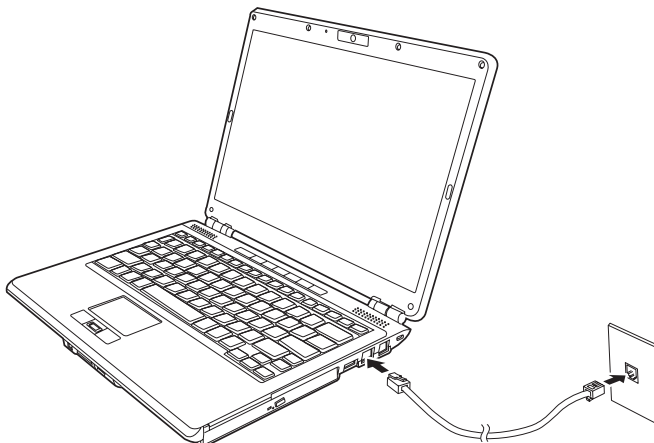

Connecting the LAN cable

3. Plug the other end of the cable into a LAN hub connector. Check with your LAN administrator before connecting to a hub.

Disconnecting LAN cable

To disconnect the LAN cable, follow the steps below.

1. Pinch the lever on the connector in the computer's LAN jack and pull out the connector.
2. Disconnect the cable from the LAN hub in the same manner. Check with your LAN administrator before disconnecting from the hub.

Cleaning the computer

To help ensure long, trouble-free operation, keep the computer free of dust and use care with liquids around the computer.

- Be careful not to spill liquids into the computer. If the computer does get wet, turn the power off immediately and let the computer dry completely before you turn it on again.
- Clean the computer using a slightly damp (with water) cloth. You can use glass cleaner on the display. Spray a small amount of cleaner on a soft, clean cloth and wipe the screen gently with the cloth.



Never spray cleaner directly onto the computer or let liquid run into any part of it. Never use harsh or caustic chemical products to clean the computer.

- Remove the dust from the cooling vents on the Left side of the computer regularly with a vacuum cleaner. Refer to Chapter 2, *The Grand Tour, Left side*.

Moving the computer

The computer is designed for rugged durability. However, a few simple precautions taken when moving the computer will help ensure trouble-free operation.

- Before moving the computer, it recommends changing the function of TOSHIBA HDD Protection. Refer to the section, *Using the Hard Disk Drive (HDD) Protection*, in this chapter.
- Make sure all disk activity has ended before moving the computer. Check the **HDD** indicator on the computer.
- If a CD/DVD is in the drives, remove it. Also make sure the disc tray is securely closed.
- Turn off (shut down) the computer.
- Disconnect the AC adaptor and all peripherals before moving the computer.
- Close the LCD display panel. Do not pick up the computer by its display panel.
- Before carrying your computer, shut down the computer, disconnect the power cable and wait until the PC cools down. Failure to follow this instruction could result in minor injury.
- Always turn off the power when you move the computer. If the power button has a lock, set it to the lock position. Also be careful not to subject the computer to impact. Failure to follow this instruction could result in damage to computer, computer failure or loss of data.
- Never transport your computer with PC cards installed. This could cause damage to your computer and/or PC card, resulting in product failure.

- Use the carrying case when transporting the computer.
- When carrying your computer, be sure to hold it securely so that it does not fall or hit anything.
- Do not carry your computer by holding protruded portions.

Using the Hard Disk Drive (HDD) Protection

This computer has a function for reducing the risk of damage on the hard disk drive.

Using an acceleration sensor built into the computer, TOSHIBA HDD Protection detects vibration shocks and similar signs of movement of the computer, and automatically moves the Hard Disk Drive head to a safe position to reduce the risk of damage that could be caused by head-to-disk contact.



This function does not guarantee that the hard disk drive will not be damaged.

When vibration is detected, a message will be displayed on the screen, and the icon in the taskbar notification area will change to the protection state. This message is displayed until the **OK** button is pressed or 30 seconds pass. When vibration subsides, the icon returns to the normal state.

Taskbar Icon

State	Icon	Description
Normal		TOSHIBA HDD Protection is enabled.
Protection		TOSHIBA HDD Protection is active. The hard disk drive head is in a safe position.
OFF		TOSHIBA HDD Protection is disabled.

TOSHIBA HDD Protection Properties

You can change the TOSHIBA HDD Protection settings by using the TOSHIBA HDD Protection Properties window. To open the window, click **start** → **All Programs** → **TOSHIBA** → **Utilities** → **HDD Protection Setting**. The window can also be started from the icon on the Taskbar or from the **Control Panel**.

HDD Protection

You can choose whether to enable or disable TOSHIBA HDD Protection.

Detection Level

This function can be set to four levels. The sensitivity levels in which vibrations, impacts and their similar signs are detected can be set to OFF, 1, 2 and 3 in ascending order. Level 3 is recommended for better protection of the computer. However, when the computer is used in a mobile environment or in other unstable conditions, setting the detection level to 3 could result in frequent execution of TOSHIBA HDD Protection, which will slow Hard Disk Drive reading and writing. Set a lower detection level when the speed of Hard Disk Drive reading and writing is a priority.

Different detection levels can be set depending on whether the computer is used as handheld or mobile usages, or whether it is used in a stable environment such as on a table in the workplace or at home. By setting different detection levels for the computer depending on whether it runs with the AC power (desktop) or with batteries (handheld or mobile usage), the detection level automatically switches according to the power connection mode.

3D Viewer

This feature displays a 3D object on the screen which moves in according to tilting or vibration of the computer.

When the TOSHIBA HDD Protection detects computer vibration the Hard Disk Drive head is parked and the 3D object disk rotation will stop. When the head is un-parked the disk will begin to rotate again.

The **3D Viewer** can be started from the icon in the task tray.



- *This 3D object virtually represents the Computer's internal Hard Disk Drive. This representation may vary from the actual number of disks, disk rotation, head movement, part size, shape and direction.*
- *This feature may use a large amount of CPU and memory on some models. The computer may become slow or sluggish when attempting to run other applications while the 3D Viewer is displayed.*
- *Intensely shaking the computer or other subjecting it to strong impacts may cause damage to the computer.*

Details

To open the Details window, click the **Setup Detail** button in the TOSHIBA HDD Protection Properties window.

Detection Level Amplification

When the AC adaptor is disconnected or the lid is closed, HDD Detection assumes that the computer will be carried and sets the detection level to the maximum for 10 seconds.

TOSHIBA HDD Protection Message

Specify whether to display a message when TOSHIBA HDD Protection is active.



- *This function does not work when the computer is starting, in Standby Mode, in Hibernation Mode, in transition to Hibernation Mode, recovering from Hibernation Mode, or powered off. Be sure to not subject the computer to vibration or impact while the function is disabled.*
- *This function only operates with Windows XP.*

Chapter 5

The Keyboard

The computer's keyboard layouts are compatible with a 101/102-key enhanced keyboard. By pressing some keys in combination, all the 101/102-key keyboard functions can be executed on the computer.

The number of keys on your keyboard depends on which country/region's keyboard layout your computer is configured with. Keyboards for numerous languages are available.

There are six types of keys: typewriter keys, keypad overlay, function keys, soft keys, Windows® special keys, and cursor control keys.

Typewriter keys

The typewriter keys produce the upper- and lower-case letters, numbers, punctuation marks, and special symbols that appear on the screen.

There are some differences, however, between using a typewriter and using a computer keyboard:

- Letters and numbers produced in computer text vary in width. Spaces, which are created by a "space character," may also vary depending on line justification and other factors.
- The lowercase l (el) and the number 1 (one) are not interchangeable on computers as they are on a typewriter.
- The uppercase O (oh) and the 0 (zero) are not interchangeable.
- The **Caps Lock** function key locks only the alphabetic characters in uppercase while the shift lock on a typewriter places all keys in the shifted position.
- The **Shift** keys, the **Tab** key, and the **BackSpace** key perform the same function as their typewriter counterparts but also have special computer functions.

F1 ... F12 function keys

The function keys (not to be confused with **Fn**) are the 12 keys at the top of your keyboard. These keys function differently from other keys.

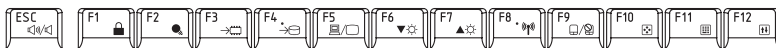

F1 through **F12** are called function keys because they execute programmed functions when pressed. Used in combination with the **Fn** key, keys marked with icons execute specific functions on the computer. Refer to the section, *Soft keys: Fn key combinations*, in this chapter. The function executed by individual keys depends on the software you are using.

Soft keys: Fn key combinations

The **Fn** (function) is used in combination with other keys to form soft keys. Soft keys are key combinations that enable, disable or configure specific features.



Some software may disable or interfere with soft-key operations. Soft-key settings are not restored by the Standby Mode feature.

Emulating keys on enhanced keyboard

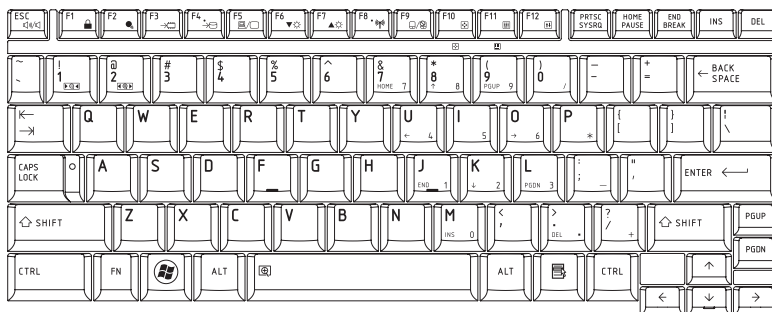

A 101-key enhanced keyboard layout

The keyboard is designed to provide all the features of the 101-key enhanced keyboard, shown in figure above. The 101/102-key enhanced keyboard has a numeric keypad and scroll lock key. It also has additional **Enter** and **Ctrl** keys to the right of the main keyboard. Since the keyboard is smaller and has fewer keys, some of the enhanced keyboard functions must be simulated using two keys instead of one on the larger keyboard.

Your software may require you to use keys that the keyboard does not have. Pressing the **Fn** key and one of the following keys simulates the enhanced keyboard's functions.

Press **Fn + F11** to access the integrated keypad. When activated, the keys with gray markings on the bottom edge become numeric keypad keys. Refer to the [Keypad overlay](#) section in this chapter for more information on how to operate these keys. The power on default for both settings is off.

Press **Fn + F12** to lock the cursor on a specific line. The power on default is off.

Hot keys

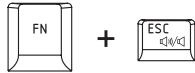

Mute: Turns the volume on and off.

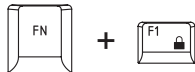

Lock: Enters "Lock computer" mode. To restore your desktop, you need to log on again.



Power plan: Displays the power save modes and lets you change the power settings.



Standby: This hot key switches the system to Standby Mode.



Hibernate: This hot key switches the system to Hibernate mode.

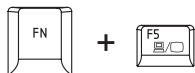

Output: Changes the active display device.



Default resolution for simultaneous mode is set to 1024x768. If you connect an RGB (Monitor) that is not 1024x768 resolution, change it in "Display Properties".



Brightness (decreases): Turns the monitor brightness down.



Brightness (increases): Turns the monitor brightness up.

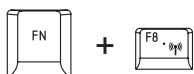

Wireless: Switches the active wireless devices if the wireless communication switch is switched on.



TouchPad: Enables or disables the Touch Pad function.



Enable Keypad: Enables or disables the Key Pad function.



Number Lock: Enables or disables the Number Lock function.



Scroll Lock: Enables or disables the Scroll Lock function.

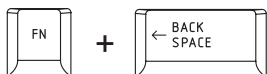

Zoom: Changes the display resolution.



TOSHIBA Zooming Utility (reduce): Reduces the icon size on the desktop or the font size within one of the supported application windows.

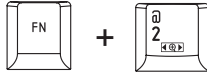

TOSHIBA Zooming Utility (enlarge): Increases the icon size on the desktop or the font size within one of the supported application windows.



Before using Fn+1 and Fn+2, you must install the TOSHIBA Zooming Utility. The Utility only supports the following application windows: Microsoft Internet Explorer, Microsoft Office, Windows Media Player, Adobe Reader and the icons on the desktop.

Fn Sticky key (Depends on the model you purchased)

You can use the TOSHIBA Accessibility Utility to make the **Fn** key sticky, that is, you can press it once, release it, and then press an "**F number**" key. To start the TOSHIBA Accessibility Utility, click **start**, point to **All Programs**, point to **TOSHIBA**, point to **Utilities** and click **Accessibility**.

Windows[®] special keys

The keyboard provides two keys that have special functions in Windows[®] : Windows[®] logo key activates the **start** menu and the other, the application key, has the same function as the secondary mouse button.



This key activates the Windows[®] **start** menu.



This key has the same function as the secondary mouse button.

Keypad overlay

Your computer's keyboard does not have an independent numeric keypad, but its numeric keypad overlay functions like one.

The keys in the centre of the keyboard with gray letters make up the numeric keypad overlay. The overlay provides the same functions as the numeric keypad on the 101/102-key enhanced keyboard described previously.

Turning on the overlays

The numeric keypad overlay can be used for numeric data input.

Numeric mode

To turn on the Numeric mode, press **Fn + F11**. Now try numeric data entry using the keys in the following figure. Press **Fn + F11** again to turn off the overlay.

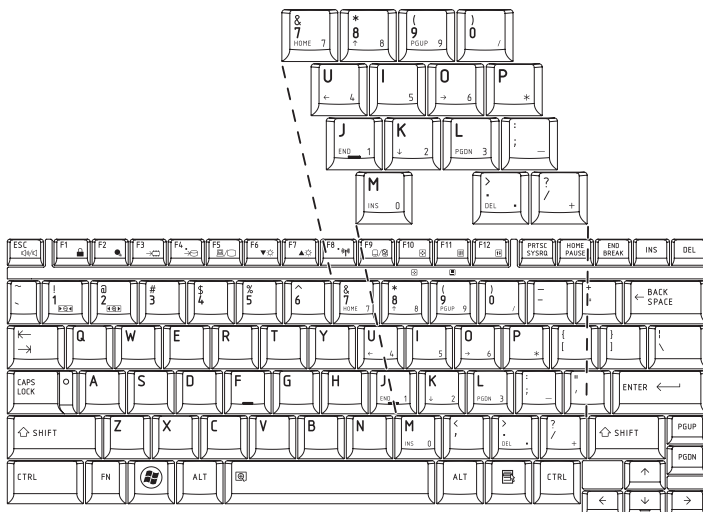

The numeric keypad overlay

Temporarily using normal keyboard (overlay on)

While using the overlay, you can temporarily access the normal keyboard without turning off the overlay:

1. Hold **Fn** and press any other key. All keys will operate as if the overlay were off.
2. Type upper-case characters by holding **Fn + Shift** and pressing a character key.
3. Release **Fn** to continue using the overlay.

Generating ASCII characters

Not all ASCII characters can be generated using normal keyboard operation. But, you can generate these characters using their ASCII codes.

With the overlay on:

1. Hold down **Alt**.
2. Using the overlay keys, type the ASCII code.
3. Release **Alt**, and the ASCII character appears on the display screen.

With the overlay off:

1. Hold down **Alt + Fn**.
2. Using the overlay keys, type the ASCII code.
3. Release **Alt + Fn**, and the ASCII character appears on the display screen.

Chapter 6

Power and Power-Up Modes

The computer's power resources include the AC adaptor and internal batteries. This chapter gives details on making the most effective use of these resources including charging and changing batteries, tips for saving battery power, and power up modes.

Power conditions

The computer's operating capability and battery charge status are affected by the power conditions: whether an AC adaptor is connected, whether a battery is installed and what the charge level is for the battery.

Table Power conditions

		Power on	Power off (no operation)
Universal AC adaptor connected	Battery fully charged	<ul style="list-style-type: none"> Operates LED: Battery blue 	<ul style="list-style-type: none"> LED: Battery blue
	Battery partially charged or no charge	<ul style="list-style-type: none"> Operates Quick Charge LED: Battery orange 	<ul style="list-style-type: none"> Quick charge LED: Battery orange
	No battery installed	<ul style="list-style-type: none"> Operates No charge LED: Battery off 	<ul style="list-style-type: none"> No charge LED: Battery off
Universal AC adaptor not connected	Battery charge is above low battery trigger point	<ul style="list-style-type: none"> Operates LED: Battery off 	
	Battery charge is below low battery trigger point	<ul style="list-style-type: none"> Operates LED: Battery flashes orange 	
	Battery charge is exhausted	Computer shuts down	
	No Battery installed	<ul style="list-style-type: none"> Cannot operates LED: Battery off 	

Power indicators

As shown in the above table, the **Battery. Power** indicators on the system indicator alert you to the computer's operating capability and battery charge status.

Battery indicator

Check the **Battery** indicator to determine the status of the battery pack. The following indicator lights indicate the battery status:

Flashing orange	The battery charge is low. The AC adaptor must be connected to recharge the battery.
Orange	Indicates the AC adaptor is connected and charging the battery.
Blue	Indicates the AC adaptor is connected and the battery is fully charged.
No light	Under any other conditions, the indicator does not light.



If the battery becomes too hot while it is being charged, the charge will stop and the battery indicator will go out. When the battery's temperature falls to a normal range, charge will resume. This occurs whether the computer's power is on or off.

Power indicator

Check the **Power** indicator to determine the power status:

Blue	Indicates power is being supplied to the computer and the computer is turned on.
Blinking orange	Indicates power is being supplied to the computer while the computer is in Standby Mode. The indicator turns on for one second and off for two seconds.
No light	Under any other conditions, the indicator does not light.

Battery types

The computer has the following batteries:

- Battery pack (3cell, 6cell, or 9cell depending on the model.)
- Real Time Clock (RTC) battery



- *The battery pack is a lithium ion battery, which can explode if not properly replaced, used, handled or disposed of. Dispose of the battery as required by local ordinances or regulations. Use only batteries recommended by TOSHIBA as replacements.*
- *Do not remove the battery pack while the computer is in Standby Mode. Data is stored in RAM, so if the computer loses power it will be lost. When the computer is powered off in Standby Mode, and the AC adaptor is not connected, the main battery pack supplies power to maintain data and programs in memory. If the battery pack is completely discharged, Standby Mode does not function and the computer loses all data in memory.*

Battery pack

When the AC adaptor is not connected, the computer's main power source is a removable lithium ion battery pack, also referred to in this manual as the main battery. You can purchase additional battery packs for extended use of the computer away from an AC power source.

Before you remove the battery pack, set the computer to Hibernation Mode or save your data and shut down the computer. Do not change the battery pack while the AC adaptor is connected.

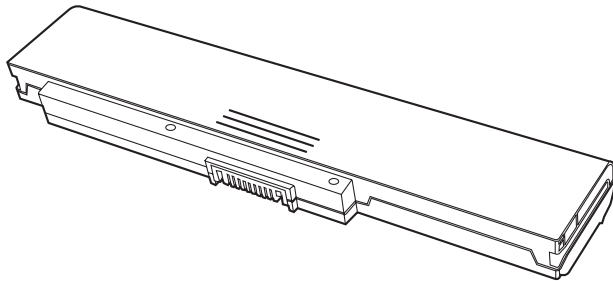

Battery pack

To ensure that the battery pack maintains its maximum capacity, operate the computer on battery power at least once a month until the battery pack is fully discharged. Refer to [Extending battery life](#) in this chapter for procedures. If the computer is continuously operated on AC power through an AC adaptor for an extended period, more than a month, the battery may fail to retain a charge. It may not function efficiently over the expected life of the battery and the **Battery** indicator may not indicate a low-battery condition.

Real Time Clock battery

The Real Time Clock (RTC) battery provides power for the internal real time clock and calendar. It also maintains the system configuration.

If the RTC battery becomes completely discharged, the system loses this data and the real time clock and calendar stop working.



The computer's RTC battery is a lithium ion battery and should be replaced only by your dealer or by a TOSHIBA service representative. The battery can explode if not properly replaced, used, handled or disposed of. Dispose of the battery as required by local ordinances or regulations.



- You can change the settings of the Real Time Clock by pressing **F2** in POST.
- After configuring the time and date for the Real Time Clock battery, we recommend that you turn the power status of your computer to "ON" so that the Real Time Clock battery is charged. Refer to [Chapter 9 Troubleshooting](#), for details.

If the following message is displayed on the LCD:

ERROR 0271: Check date and time settings.

WARNING 0251: System CMOS checksum bad-Default configuration used.

Press [F1] to resume, [F2] to setup.

The charge in the RTC battery is getting low or has been exhausted. You will need to set the date and time within the BIOS setup using the following steps:

1. Press **F2** key - the BIOS setup screen will be displayed.
2. Set the date in **System Date**.
3. Set the time in **System Time**.
4. Press **F10** key. Confirmation message will appear.

Press **Enter** key. BIOS setup will terminate and the computer will be rebooted.



After configuring the date and time it is recommended that you switch the computer on and then leave it in this state so that the Real Time Clock battery can be charged.

Care and use of the battery pack

The battery pack is a vital component of portable computing. Taking proper care of it will help ensure longer operating time on battery power as well as a longer life for your battery pack. Follow the instructions in this section carefully to ensure safe operation and maximum performance.

Safety precautions

Mishandling of batteries can cause death, serious injury or property damage. Carefully observe the following advisories:

Danger: Indicates an imminently hazardous situation, which could result in death or serious injury, if you do not follow instructions.

Warning: Indicates a potentially hazardous situation, which could result in death or serious injury, if you do not follow instructions.

Caution: Indicates a potentially hazardous situation, which if not avoided, may result in moderate or minor injury or property damage.

Note: Provides important information.

Danger

1. Never try to dispose of the battery pack by burning or expose it to a heating device such as a microwave oven. The battery pack could explode and cause bodily injury.
2. Never try to disassemble, repair or otherwise tamper with a battery pack. The battery pack will overheat and ignite. Leakage of caustic alkaline solution or other electrolytic substances will cause fire or injury, possibly resulting in death or serious injury.
3. Never short-circuit the battery pack by contacting the terminals with a metal object. A short-circuit can cause fire or otherwise damage the battery pack and possibly cause injury. To avoid accidental short-circuit, always wrap the battery pack in plastic and cover the terminals with electrical tape when storing or disposing of the battery pack.
4. Never puncture the battery pack with a nail or other sharp object. Never strike it with a hammer or other object. Never step on it.
5. Never try to charge the battery pack in any manner other than that described in the User's manual. Never connect the battery pack to a plug socket or to an automobile's cigarette lighter socket. It may rupture or ignite.
6. Use only the battery pack supplied with the computer or other device or a battery pack approved by the computer or device's manufacturer. Battery packs have different voltages and terminal polarities. Use of an improper battery could cause smoke, fire or rupture of the battery pack.
7. Never subject a battery pack to heat, such as storage near a heat source. Exposure to heat can cause the battery pack to ignite, explode or leak caustic liquid and cause death or serious injury. It could also fail or malfunction causing data loss.

8. Never expose the battery pack to abnormal shock, vibration or pressure. The battery pack's internal protective device will fail, causing it to overheat, explode, ignite or leak caustic liquids possibly resulting in death or serious injury.
9. Never let a battery pack become wet. A wet battery pack will overheat, ignite or rupture possibly resulting in death or serious injury.

Warning

1. Never allow caustic electrolyte fluid leaked from a battery pack to contact your eyes, skin or clothing. If caustic electrolyte fluid should contact your eyes, immediately wash your eyes with large amounts of running water and seek medical attention, to help prevent eye damage. If electrolyte fluid should contact your skin immediately wash it under running water to prevent rash. If it contacts your clothes, promptly remove them to prevent the fluid from contacting your skin or eyes.
2. Immediately turn off the power, disconnect the AC adaptor and remove the battery if any of the following events are observed in the battery pack: offensive or unusual odor, excessive heat, discoloration or deformation. Never use the computer again until it has been checked by a TOSHIBA service provider. It might generate smoke or fire, or the battery pack might rupture.
3. Make sure the battery is securely installed in the computer before attempting to charge the battery pack. Improper installation could generate smoke or fire, or cause the battery pack to rupture.
4. Keep the battery pack out of reach of infants and children. It can cause injury.

Caution

1. Never continue to use a battery pack after its recharging capacity has become impaired, or after the display of a warning message indicating that the battery pack's power is exhausted. Continued use of an exhausted or impaired battery pack could cause the loss of data.
2. Never dispose of battery packs with normal trash. Bring them to your TOSHIBA dealer or to another recycling centre to save resources and prevent environmental damage. Cover the terminals with electrical tape to prevent short-circuits, which could cause the battery pack to ignite or rupture.
3. Use only battery packs recommended by TOSHIBA as replacements.
4. Always make sure the battery pack is installed correctly and securely. Otherwise, a battery pack could fall out and possibly cause injury.
5. Charge the battery pack only in an ambient temperature between 5 and 35 degrees Celsius. Otherwise, the electrolyte solution might leak, battery pack performance might deteriorate and the battery life might be shortened.

6. Be sure to monitor the remaining battery power. If the battery pack and real time clock battery discharge completely, Standby Mode will not function and data in memory will be lost. Also, the computer might register an incorrect time and date. In this case, connect the AC adaptor to recharge the batteries.
7. Never install or remove the battery pack without first turning off the power and disconnecting the AC adaptor. Never remove the battery pack while the computer is in Suspend or Standby Mode. Data will be lost.

Note

1. Never remove the battery pack while the Wake-up on LAN function is enabled. Data will be lost. Before you remove a battery pack, disable the Wake-up on LAN function.
2. After the battery pack is charged, avoid leaving the AC adaptor connected and the computer turned off for more than a few hours at a time. Continuing to charge a fully-charged battery pack can damage the battery.

Charging the batteries

When the power in the battery pack becomes low, the **Battery** indicator flashes orange indicating that only a few minutes of battery power remain. If you continue to use the computer while the **Battery** indicator flashes, the computer enables Hibernation Mode (so you don't lose data) and automatically turns off.

You must recharge a battery pack when it becomes discharged.

Procedures

To recharge a battery pack while it is installed in the computer, connect the AC adaptor to the **DC IN 19V** jack and plug the other end into a working outlet.

The **Battery** indicator glows orange when the battery is being charged.



Use only the computer connected to an AC power source to charge the battery pack. Never attempt to charge the battery pack with any other charger.

Time

The following table shows the approximate time required to fully charge a discharged battery.

Charging time (hours)

Battery type	Power on	Power off
Battery pack (3cell, 6cell, 9cell)	About 12 or longer	About 4
RTC battery	About 24	Doesn't charge



The charging time when the computer is on is affected by ambient temperature, the temperature of the computer and how you use the computer. If you make heavy use of external devices, for example, the battery might scarcely charge at all during operation. Refer also to the section [Maximizing battery operating time](#).

Battery charging notice

The battery may not charge right away under the following conditions:

- The battery is extremely hot or cold. If the battery is extremely hot, it might not charge at all. To ensure the battery charges to its full capacity, charge the battery at room temperature of 10° to 30°C (50° to 88°F).
- The battery is nearly completely discharged. Leave the AC adaptor connected for a few minutes and the battery should begin charging.

The **Battery** indicator may show a rapid decrease in battery operating time when you try to charge a battery under the following conditions:

- The battery has not been used for a long time.
- The battery has completely discharged and been left in the computer for a long time.
- A cool battery is installed in a warm computer.

In such case, follow the steps below.

1. Fully discharge the battery by leaving it in the computer with the power on until the power automatically shuts off.
2. Plug in the AC adaptor.
3. Charge the battery until the **Battery** indicator glows blue.

Repeat these steps two or three times until the battery recovers normal capacity.



Leaving the AC adaptor connected will shorten battery life. At least once a month, run the computer on battery power until the battery is fully discharged, then recharge the battery.

Monitoring battery capacity

Remaining battery power can be monitored using the following methods.

- Clicking the battery icon on the task bar
- Via the Windows Mobility Center window



- *Wait at least 16 seconds after turning on the computer before trying to monitor the remaining operating time. The computer needs this time to check the battery's remaining capacity and to calculate the remaining operating time, based on the current power consumption rate and remaining battery capacity. The actual remaining operating time may differ slightly from the calculated time.*
- *With repeated discharges and recharges, the battery's capacity will gradually decrease. Therefore, an often used, older battery will not operate for as long as a new battery even when both are fully charged.*

Maximizing battery operating time

A battery's usefulness depends on how long it can supply power on a single charge.

How long the charge lasts in a battery depends on:

- CPU processing speed (Depends on the model you purchased)
- Screen brightness
- Cooling method (Depends on the model you purchased)
- System Standby Mode
- System Hibernation
- Monitor power off
- How often and how long you use the hard disk, optical disc.
- How much charge the battery contained to begin with.
- How you use optional devices, such as a PC Card, to which the battery supplies power.
- Enabling Standby Mode conserves battery power if you are frequently turning the computer off and on.
- Where you store your programs and data.
- Closing the display when you are not using the keyboard saves power.
- Operating time decreases at low temperatures.
- The condition of the battery terminals. Make sure the battery terminals stay clean by wiping them with a clean dry cloth before installing the battery pack.

Retaining data with power off

When you turn off your computer with fully charged batteries, the batteries retain data for the following approximate time periods.

Battery pack (3cell, 6cell, 9cell)	Approximately 1.5 days (Standby Mode, 3-cell)
	Approximately 3 days (Standby Mode, 6-cell)
	Approximately 5 days (Standby Mode, 9-cell)
	Approximately 1 month (Shut down mode, All type of battery packs)

RTC battery	Approximately 1 month
--------------------	-----------------------

Extending battery life

To maximize the life of your battery pack:

- At least once a month, disconnect the computer from a power source and operate it on battery power until the battery pack fully discharges. Before doing so, follow the steps below.
 1. Turn off the computer's power.
 2. Disconnect the AC adaptor and turn on the computer's power. If it does not turn on go to step 4.
 3. Operate the computer on battery power for five minutes. If the battery pack has at least five minutes of operating time, continue operating until the battery pack is fully discharged. If the **Battery** indicator flashes or there is some other warning to indicate a low battery, go to step 4.
 4. Connect the AC adaptor to the computer and the power cord to a power outlet. The **Battery** indicator should glow orange to indicate that the battery pack is being charged. If the **Battery** indicator does not glow, power is not being supplied. Check the connections for the AC adaptor and power cord.
 5. Charge the battery pack until the Battery indicator glows blue.
- If you have extra battery packs, rotate their use.
- If you will not be using the system for an extended period, more than one month, remove the battery pack.
- Store spare battery packs in a cool dry place out of direct sunlight.

Replacing the battery pack

When the battery pack reaches the end of its operating life you will need to install a new one. The life of the battery pack is generally about 500 recharges. If the **Battery** indicator flashes orange shortly after fully recharging the battery, the battery pack needs to be replaced.

You might also replace a discharged battery pack with a charged spare when you are operating your computer away from an AC power source. This section explains how to remove and install the battery pack.

Removing the battery pack

To replace a discharged battery, follow the steps below.



- *When handling battery packs, do not short-circuit the terminals. Also do not drop, hit or otherwise apply impact; do not scratch or break the casing and do not twist or bend the battery pack.*
- *Do not remove the battery pack while the computer is in Standby Mode. Data is stored in RAM, so if the computer loses power it will be lost.*
- *In Hibernation Mode, data will be lost if you remove the battery or disconnect the AC adaptor before the save is completed. Wait for the **Built-in HDD** indicator to go out.*
- *Do not touch the latch while holding the computer. Or you may get injured by the dropped battery by unintentional release of the latch.*

1. Save your work.
2. Turn the computer's power off. Make sure the **Power** indicator is off.
3. Remove all cables connected to the computer.
4. Turn the computer upside down.
5. Slide and hold the battery release latch to free the battery pack after moving the battery pack lock into its unlock position - then slide the battery pack out of the computer.

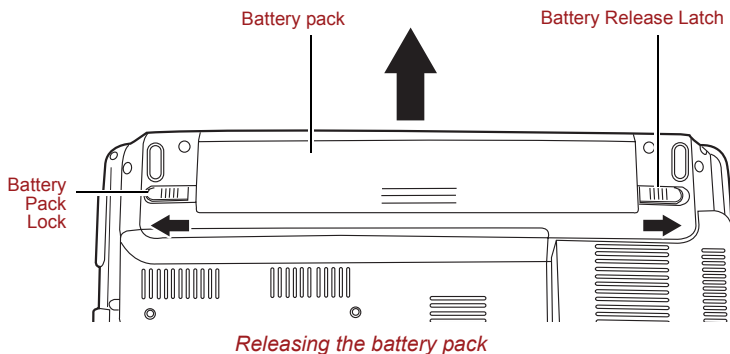

Installing the battery pack

To install a battery, follow the steps below.



- *The battery pack is a lithium ion battery, which can explode if not properly replaced, used, handled or disposed of. Dispose of the battery as required by local ordinances or regulations. Use only batteries recommended by TOSHIBA as replacements.*
- *Do not touch the latch while holding the computer. Or you may get injured by the dropped battery by unintentional release of the latch.*

1. Turn the computer's power off.
2. Disconnect all cables connected to the computer.
3. Insert the battery pack.
4. Ensure the battery pack lock is moved into its locked position.

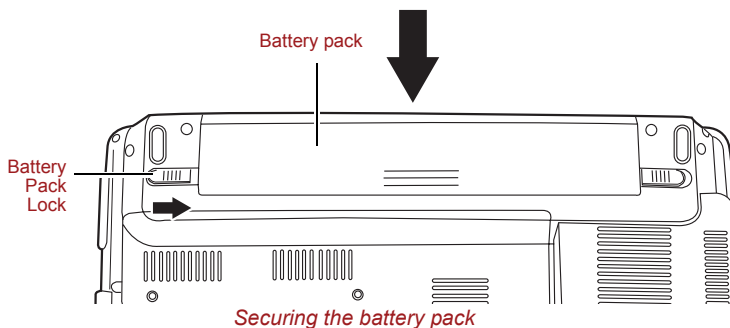

Starting the computer by password

To start up the computer with the user password, follow these steps:

1. Turn on the power as described in Chapter 3, *Getting Started*. The following message appears:



Password=



*At this point, the hotkeys **Fn + F1** to **F9** do not work. They will function after you enter the password.*

2. Enter the password.
3. Press **Enter**.



If you enter the password incorrectly three times in a row, the computer shuts off. In this case, you must turn the computer back on to retry password entry.

or if available

Swipe your fingerprint on the sensor if you have already registered the fingerprint with the Fingerprint utility and enabled **Fingerprint Power on Security**. If you would not like to swipe your finger or cannot authenticate the fingerprint for some reasons, push the **BkSp** key to skip the fingerprint authentication screen. You can try to swipe the fingerprint up to five times. If you failed fingerprint authentication more than five times, you must enter the password manually to start the computer.

Power-up modes

The computer has the following power-up modes:

- **Boot Mode:** Computer shuts down without saving data. Always save your work before you turn the computer off in boot mode.
- **Hibernation Mode:** Data in memory is saved to the hard disk.
- **Standby Mode:** Data is maintained in the computer's main memory.



Refer also to the sections *Turning on the power* and *Turning off the power* in Chapter 3, *Getting Started*.

Hot keys

You can use hot keys **Fn + F3** to enter Standby Mode and **Fn + F4** to enter Hibernation Mode. Refer to Chapter 5, *The Keyboard* for details.

Panel power off/on

You can set up your computer so that power turns off automatically when you close the display panel. When you open the panel, power turns on in Standby Mode or Hibernation Mode but not in boot mode.



If the panel power off function is enabled and you use Shut down Windows[®], do not close the display until the shut down function is completed.

System Auto Off

This feature turns the system off automatically if it is not used for a set duration. The system shuts down in Standby Mode or Hibernation Mode in Windows[®].

Chapter 7

HW Setup

This chapter explains how to use TOSHIBA HW Setup program to configure your computer. TOSHIBA HW Setup lets you configure settings for General, Password, Display, Boot Priority, Keyboard, LAN, and USB.

Accessing HW Setup

To run HW Setup, click **start**, click **Control Panel**, click Printers and Other Hardware and select **TOSHIBA HW Setup**.

HW Setup Window

The HW Setup window contains the following tabs: General, Password, Display, Boot Priority, Keyboard, USB and LAN .

There are also these three buttons:

OK	Accepts your changes and closes the HW Setup window.
Cancel	Closes the window without accepting your changes.
Apply	Accepts all your changes without closing the HW Setup window.

General

This window displays the BIOS version and contains two buttons:

Default	Return all HW Setup values to the factory settings.
About	Display the HW Setup version.

Setup

This field displays BIOS Version and date.

Password

This tab allows you to set or reset the user password for power on.

User Password

Lets you register a new password or un-register an existing password.

Not Registered	Un-registers an existing password
Registered	Register a new password by following the on screen instructions

Owner String

This blank field is used to display a message when the password field is displayed on startup. If a password is not registered the message will not be shown. The maximum length is 256 characters.

Display

This tab lets you select the internal LCD and/or external monitor when the computer boots up.

Power On Display

Lets you select the display to be used when the computer is booted (This setting is only available on Standard VGA mode and not available on Windows® Desktop).

Auto-Selected	Selects an external monitor if one is connected. Otherwise, it selects the internal LCD (Default).
LCD + Analog RGB	Selects both the internal LCD and external monitor for simultaneous display.

Boot Priority

Boot Priority Options

This option sets the priority for booting the computer.

To select the boot drive you want, follow the steps below.

1. Boot-up your computer and press **F12** to enter the boot menu.
2. The boot select screen will be displayed: Hard disk Drive, CD/DVD, FDD and LAN.
3. Use the upper/lower cursor keys to highlight the boot device you want and apply.

Keyboard

Wake-up on Keyboard

When this feature is enabled and the computer is in Standby Mode, you can turn on the computer by pressing any key. It is effective only for the internal keyboard and only when the computer is in Standby Mode.

Enabled	Enables the Wake-up on Keyboard function.
Disabled	Disables the Wake-up on Keyboard function (Default).

USB

USB Keyboard/Mouse/FDD Legacy Emulation

Use this option to enable or disable Legacy USB support. If your operating system does not support USB, you can still use a USB mouse, keyboard, and FDD by setting the Legacy USB Support to enable.

LAN

Built-in LAN

This feature enables or disables the Built-in LAN.

Enabled	Enables Built-in LAN function (Default).
Disabled	Disables Built-in LAN function.

Chapter 8

Optional Devices

Optional devices can expand the computer's capabilities and its versatility. This chapter describes connection or installation of the following devices, which are available from your TOSHIBA dealer:

Cards/memory

- PC Card and Express Card
- SD (Secure Digital) / MMC (Multi Media Card) / MS (Memory Stick) / MS Pro (Memory Stick Pro) / xD (xD-Picture Card) cards
- Memory expansion

Power devices

- Additional battery pack
- Additional AC adaptor

Peripheral devices

- External monitor

Other

- Security lock

PC Card and Express Card

The computer is equipped with a PC Card expansion slot that can accommodate one Type II card or one Express Card. Any PC Card that meets industry standards (manufactured by TOSHIBA or other vendor) can be installed. The slot supports 16-bit PC Cards, including PC Card 16's multifunction card and CardBus PC Cards.

CardBus supports the new standard of 32-bit PC Cards. The bus provides superior performance for the greater demands of multimedia data transmission.

The Express Card expansion slot can accommodate two standard module formats; an Express Card/34 module and an Express Card/54 module. An Express Card module is a small, modular add-in card technology based on PCI Express and Universal Serial Bus (USB) interfaces.

Inserting a PC card and Express Card

One Express Card connector is located on the right side of the computer. The computer's hot-install feature lets you install Express Card while the computer's power is on.

To install an Express Card, follow the steps below.

1. Insert the Express Card.
2. Press gently to ensure a firm connection.

Windows[®] hot-install feature lets you insert a PC card and Express Card while the computer's power is on.

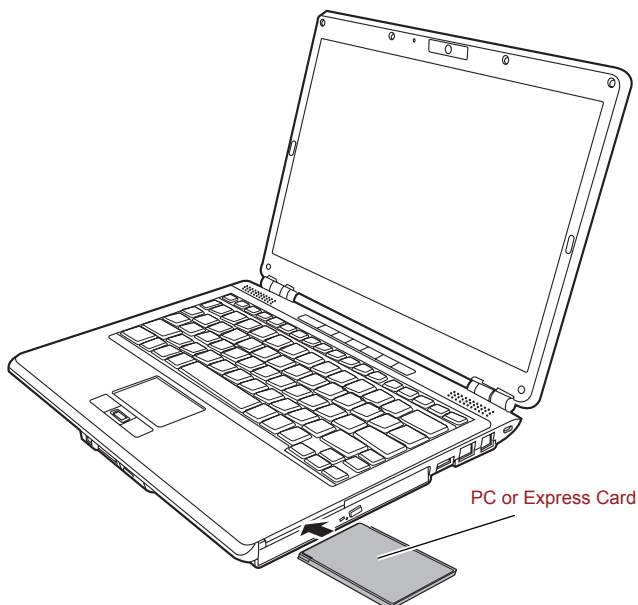

Inserting the PC or Express Card

After inserting the card, refer to the card's documentation and check the configuration in Windows® to make sure it is appropriate for your card.

Removing a PC Card or Express Card



- Before removing a Card, make sure that any applications or system services do not use the card.
- Be sure to disable the Card prior to removing it. Otherwise, the system may be fatally damaged.

To remove the PC Card, follow the steps below.

1. Click the **Safety Remove Hardware** icon on the Task Bar.
2. Click the Card you want to remove.
3. Press the Card once to extend it.
4. Grasp the extended Card, and remove it.

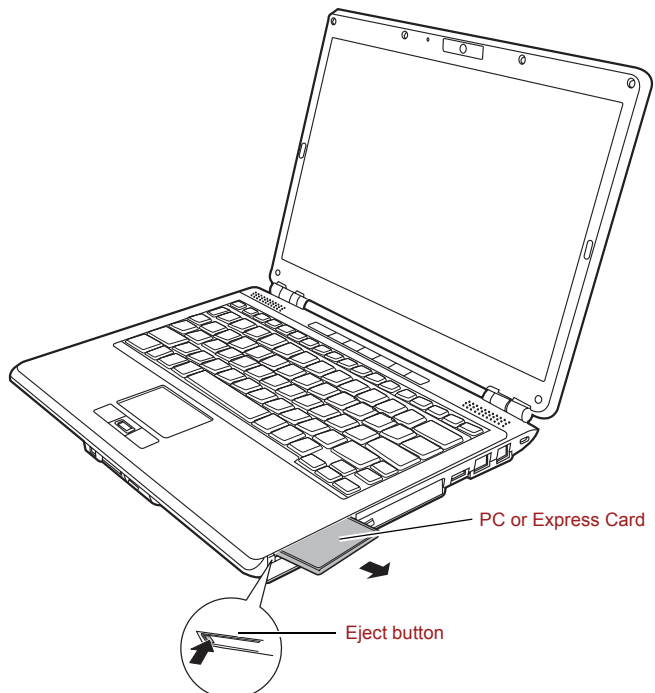

Removing the PC or Express Card

SD/MMC/MS/MS Pro/xD Memory cards

The computer is equipped with a multiple digital media card slot that can accommodate SD/MMC/MS/MS Pro/xD memory cards. These memory cards let you easily transfer data from devices, such as digital cameras and Personal Digital Assistants, which use flash-memory.

Card Type	Capacities
SD	up to 2GB
MMC	up to 2GB
MS	up to 128MB, 256MB (128MB x 2)
MS Pro	up to 2GB
xD	up to 2GB



Keep foreign objects out of the memory card slot. A pin or similar object can damage the computer's circuitry.



Do not format a memory card with Windows® as it might result in that card not being able to be used with some peripheral devices.



Memory Stick Duo/PRO Duo and the Memory Stick adaptor are not compatible with the Multiple Digital Media Card Slot. Do not insert Memory Stick Duo/PRO Duo into the slot. Data may be lost or damaged if you use any card other than those supported.



The card is designed so that it can be inserted only one way. Do not try to force the card into the slot.



For more details on using memory cards, see manuals accompanying the cards.



The Logo of SD memory card is .

Installing a memory card

To install a memory card:

1. Insert the memory card.
2. Press gently to ensure a firm connection.

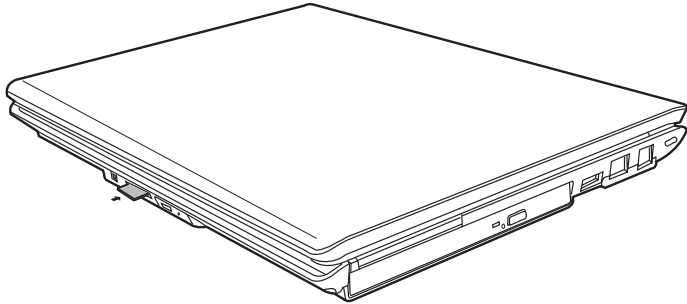

Inserting a memory card



*Be sure the memory card is oriented properly before you insert it.
If Windows® fails to read the card, remove it then re-insert it.*



■ *The multiple digital media card slot only accepts one type of card at a time. Do not attempt to install more than one card as you risk damaging either the cards themselves or the computer.*

Removing a memory card

To remove a memory card, follow the steps below:

1. Click the **Safely Remove Hardware** icon on the Taskbar.
2. Select a device, then click the **Stop** button. A confirmation dialog may appear, depending on how the device is registered with the system; if so, confirm that you want to remove the device.
3. Gently press the memory card inside the socket to eject it.
4. Grasp the card and remove it.

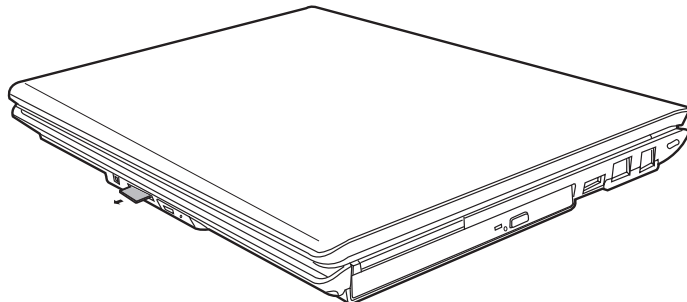

Removing a memory card



- *Make sure the memory card indicator is out before you remove the card or turn off the computer's power. If you remove the card or turn off the power while the computer is accessing the card you may lose data or damage the card.*
- *Do not remove the card while the computer is in standby or Hibernation mode. The computer could become unstable or data in the memory card could be lost.*
- *Do not turn off or place the computer into either Standby Mode or Hibernation Mode while data is being transferred to or from the memory card. The system may become unstable or data in the memory card may be lost.*

Memory card care



Set the write-protect switch to the lock position, if you do not want to record data.

1. Do not write to a memory card if the battery power is low. Low power could affect writing accuracy.
2. Do not remove a memory card while read/write is in progress.
3. The memory card is designed so that it can be inserted only one way. Do not try to force the card into the slot.
4. Do not leave a memory card partially inserted in the slot. Press the memory card until you hear it click into place.
5. Do not twist or bend memory cards.
6. Do not expose memory cards to liquids or store in humid areas or lay media close to containers of liquid.
7. After using a memory card, return it to its case.
8. Do not touch the metal part or expose it to liquids or let it get dirty.

Memory expansion

You can install additional memory in the computer's memory module socket to increase the amount of RAM. This section describes how to install and remove a memory module.



- *Use only memory modules approved by TOSHIBA.*
- *Do not try to install or remove a memory module under the following conditions. You can damage the computer and the module. Also, data will be lost.*
 - a. *The computer is turned on.*
 - b. *The computer was shut down using the Standby Mode or Hibernation Mode.*
- *When incorrect memory is inserted, please refer to [Memory expansion](#) section in Chapter 9, [Troubleshooting](#), for details.*
- *Expansion memory is a precision electronic component that may be fatally damaged by static electricity. Since the human body has slight static electricity, be sure to discharge static electricity from your body before installing an expansion memory module. To discharge your body's static electricity, simply touch any metal close to you with bare hands.*



Use a point size 1 Phillips screwdriver to remove and fasten the screws. Use of an incorrect screwdriver can damage the screw heads.

Installing a memory module

Follow the steps below to install a memory module.

1. Set the computer to boot mode and turn off the power.
2. Remove all cables connected to the computer.
3. Turn the computer upside down and remove the battery pack (refer to Chapter 6, [Power and Power-Up Modes](#)).
4. Loosen the screws securing the memory module cover.
5. Slide your fingernail or a thin object under the cover and lift it off.

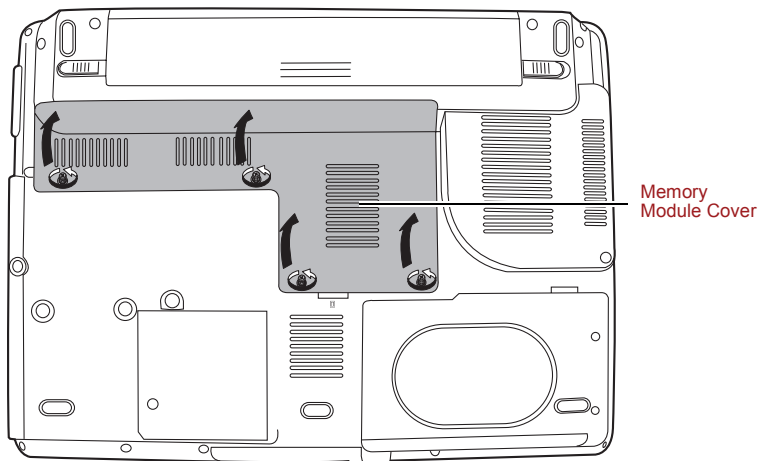

Removing the memory module cover

6. Lift one side of the insulator sheet and fit the module's connectors into the computer's connectors at about a 45 degree angle. Press the module carefully to ensure a firm connection.



Do not touch the connectors on the memory module or on the computer. Debris on the connectors may cause memory access problems.



Slot A is reserved for main memory. Use slot B for expanded memory. If only one card is installed use slot A.

7. Push the module down so it lies flat. Latches on either side will click into place to secure the module.

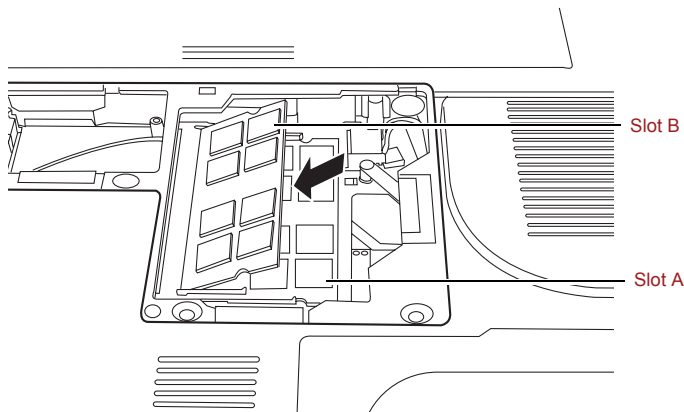

Installing the memory module

8. Seat the cover and secure it with the screws.
9. Replace the battery pack as described in Chapter 6, *Power and Power-Up Modes*.
10. Turn the power on and make sure the added memory is recognized. Open **System** in the Control Panel and click the **General** tab.

Points to note about memory module error

If you install a memory module that is not compatible with the computer, the Power indicator will flash (on for 0.5 seconds, off for 0.5 seconds) in the following ways:

- If there is only an error in Slot A: repeatedly flashes orange twice, then blue.
- If there is only an error in Slot B: repeatedly flashes orange, then blue twice.
- If there is an error in Slot A and in Slot B: repeatedly flashes orange twice, then blue twice.

In all instances you should shut down the computer and remove the incompatible module(s)

Removing a memory module

To remove the memory module, make sure the computer is in boot mode then:

1. Be sure the power is off and all cables are disconnected from the computer.
2. Turn the computer upside down and remove the battery and the screws securing the memory module cover.
3. Slide your fingernail or a thin object under the cover and lift it off.
4. Lift one side of the insulator and push the latches to the outside to release the module. A spring will force one end of the module up.
5. Grasp the module by the sides and pull it out.



- *If you use the computer for a long time, the memory modules will become hot. In this case, let the memory modules cool to room temperature before you replace them. Or you will get burnt if you touch any of them.*
- *Do not touch the connectors on the memory module or on the computer. Debris on the connectors may cause memory access problems.*

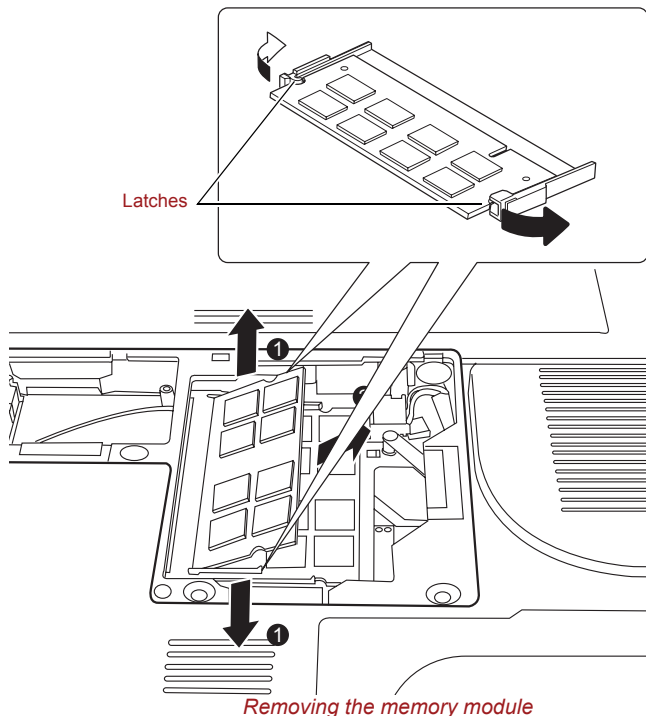

6. Seat the cover and secure it with screws and replace the battery pack.

Additional battery pack

You can increase the portability of the computer with additional battery packs. If you're away from an AC power source and your battery runs low, you can replace it with a freshly charged battery. Refer to Chapter 6, [Power and Power-Up Modes](#).

Additional AC adaptor

If you frequently transport the computer between different sites such as your home and office, purchasing an AC adaptor for each location will reduce the weight and bulk of your carrying load.

External monitor

An external analog monitor can be connected to the external monitor port on the computer. The computer supports several video modes. Refer to Appendix B, *Display Controller and Modes*. To connect a monitor, follow the steps below.

1. Turn the computer off.
2. Connect the monitor to the external monitor port.
3. Turn the monitor's power on.
4. Turn the computer on.

When you turn on the power, the Windows® Bootup screen (Windows® Logo) appears on the display device.

However, the Windows® Desktop appears on a display device that you used last time to shut down your PC, if the display device exists when you turn on the power.

To change the display settings, press **Fn+F5**. If you disconnect the monitor before you turn the computer off, be sure to press **Fn+F5** to switch to the internal display. Refer to Chapter 5, *The Keyboard*, for details on using hot keys to change the display setting.

Security lock

Security locks enable you to anchor your computer to a desk or other heavy object to help prevent unauthorized removal of the computer.

The computer has a security lock slot on the left side. Attach one end of the cable to a desk and the other end to the security lock slot.

1. Turn the computer so the left side faces you.
2. Align the holes for the security lock and attach the lock.

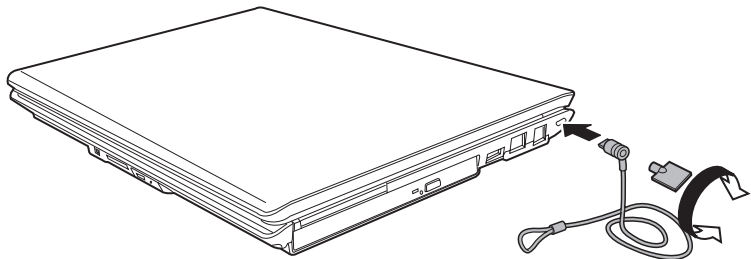

Security lock

Chapter 9

Troubleshooting

TOSHIBA designed the computer for durability. However, should problems occur, following the procedures in this chapter can help to determine the cause.

All readers should become familiar with this chapter. Knowing what might go wrong can help prevent problems from occurring.

Problem solving process

Resolving problems will be much easier if you observe the following guidelines:

- Stop immediately when you recognize a problem exists. Further action may result in data loss or damage. You may destroy valuable problem related information that can help solve the problem.
- Observe what is happening. Write down what the system is doing and what actions you performed immediately before the problem occurred. If you have a printer attached, print a copy of the screen using PrtSc.

The questions and procedures offered in this chapter are meant as a guide, they are not definitive problem solving techniques. Many problems can be solved simply, but a few may require help from your dealer. If you find you need to consult your dealer or others, be prepared to describe the problem in as much detail as possible.

Preliminary checklist

Consider the simplest solution first. The items in this checklist are easy to fix and yet can cause what appears to be a serious problem.

- Make sure you turn on all peripheral devices before you turn on the computer. This includes your printer and any other external device you are using.
- Before you attach an external device, turn the computer off. When you turn the computer back on it recognizes the new device.
- Make sure all options are set properly in the setup program.
- Check all cables. Are they correctly and firmly attached? Loose cables can cause signal errors.
- Inspect all connecting cables for loose wires and all connectors for loose pins.
- Check that your CD/DVD/CD-RW is correctly inserted.

Make notes of your observations and keep them in a permanent error log. This will help you describe your problems to your dealer. If a problem recurs, the log will help you identify the problem faster.

Analyzing the problem

Sometimes the system gives clues that can help you identify why it is malfunctioning. Keep the following questions in mind:

- Which part of the system is not operating properly: keyboard, hard disk drive, optical media drive, display. Each device produces different symptoms.
- Is the operating system configuration set properly? Check the configuration options.
- What appears on the display screen? Does it display any messages or random characters? Print a copy of the screen if you have a printer attached. Look up the messages in the software and operating system documentation. Check that all connecting cables are correctly and firmly attached. Loose cables can cause erroneous or intermittent signals.
- Do any indicators light? Which ones? What color are they? Do they stay on or blink? Write down what you see.
- Do you hear any beeps? How many? Are they long or short? Are they high pitched or low? Is the computer making any unusual noises? Write down what you hear.

Record your observations so you can describe them to your dealer.

<p>Software</p>	<p>The problems may be caused by your software or disc. If you cannot load a software package, the media may be damaged or the program might be corrupted. Try loading another copy of the software.</p> <p>If an error message appears while you are using a software package, check the software documentation. These documents usually include a problem solving section or a summary of error messages.</p> <p>Next, check any error messages in the operating system documentation.</p>
<p>Hardware</p>	<p>If you cannot find a software problem, check your hardware.</p> <p>First run through the items in the preliminary checklist above. If you still cannot correct the problem, try to identify the source. The next section provides checklists for individual components and peripherals.</p>

Hardware and system checklist

This section discusses problems caused by your computer's hardware or attached peripherals. Basic problems may occur in the following areas:

- System start-up
- Self test
- Power
- Real Time Clock
- Keyboard
- LCD panel
- Hard disk drive
- Recovery Discs
- DVD Super Multi drive
- Pointing device
- USB
- Memory expansion
- Sound system
- Monitor
- Modem
- LAN
- Wireless LAN
- FingerPrint Sensor
- PC/Express Card

System start-up

When the computer does not start properly, check the following items:

- Self Test
- Power Sources
- Power-on Password

Self test

When the computer starts up, the self test will be run automatically, and the following will be displayed:



In Touch with Tomorrow
TOSHIBA

This message remains on the screen for a few seconds.

If the self test is successful, the computer tries to load the operating system, depending on how the Boot Priority is set in the TOSHIBA HW Setup program.

If any of the following conditions are present, the self test failed:

- The computer stops and does not proceed to display information or messages except the TOSHIBA logo.
- Random characters appear on the screen, and the system does not function normally.
- The screen displays an error message.

Turn off the computer and check all cable connections. If the test fails again, contact your dealer.

Power

When the computer is not plugged into an AC outlet, the battery pack is the primary power source. However, your computer has a number of other power resources, including an intelligent power supply and a Real Time Clock battery. These resources are interrelated and any one could affect apparent power problems. This section provides checklists for AC power and the battery. If you cannot resolve a problem after following them, the cause could lie with another power resource. In such a case, contact your dealer.

Overheating power down

If the computer's internal temperature becomes too high, the computer will automatically enter Hibernation Mode or Standby Mode and shut down. If the computer has reached room temperature and still does not start, or if it starts but shuts down quickly contact your dealer.

AC power

If you have trouble turning on the computer with the AC adaptor connected, check the **Battery** indicator. Refer to Chapter 6, *Power and Power-Up Modes* for more information.

Problem	Procedure
AC adaptor doesn't power the computer	<p>Check the connections. Make sure the cord is firmly connected to the computer and a power outlet.</p> <hr/> <p>Check the condition of the cord and terminals. If the cord is frayed or damaged, replace it. If the terminals are soiled, wipe them with cotton or a clean cloth.</p> <hr/> <p>If the AC adaptor still does not power the computer, contact your dealer.</p>

Battery

If you suspect a problem with the battery, check the **Battery** indicator. For information on indicator and battery operation refer to Chapter 6, *Power and Power-Up Modes*.

Problem	Procedure
Battery doesn't power the computer	The battery may be discharged. Connect the AC adaptor to charge the battery.
Battery doesn't charge when the AC adaptor is attached (Battery indicator does not glow orange.)	<p>If the battery is completely discharged, it will not begin charging immediately. Wait a few minutes.</p> <p>If the battery still does not charge, make sure the outlet of the AC adaptor is supplying power.</p> <p>Test it by plugging in an appliance.</p> <hr/> <p>Check whether the battery is hot or cold to the touch. If the battery is too hot or too cold, it will not charge properly. Let it reach room temperature.</p>

Problem	Procedure
	<p>Unplug the AC adaptor and remove the battery to make sure the terminals are clean. If necessary wipe them with a soft dry cloth dipped in alcohol.</p> <p>Connect the AC adaptor and replace the battery. Make sure it is securely seated.</p> <p>Check the Battery indicator. If it does not glow, let the computer charge the battery for at least 20 minutes. If the Battery indicator glows after 20 minutes, let the battery continue to charge at least another 20 minutes before turning on the computer.</p> <p>If the indicator still does not glow, the battery may be at the end of its operating life. Replace it.</p> <p>If you do not think the battery is at the end of its operating life, see your dealer.</p>
<p>Battery doesn't power the computer as long as expected</p>	<p>If you frequently recharge a partially charged battery, the battery might not charge to its full potential. Fully discharge the battery, then try to charge it again.</p> <hr/> <p>Check the power consumption settings in the Power Options. Consider using a power saving feature.</p>

Disposing of PC and PC batteries

- Discard this PC in accordance with applicable laws and regulations. For further information, contact your local government.
- This PC contains rechargeable batteries. After repeated use, the batteries will finally lose their ability to hold a charge and you will need to replace them. Under certain applicable laws and regulation, it may be illegal to dispose of old batteries by placing them in the trash.
- Please be kind to our shared environment. Check with your local government authority for details regarding where to recycle old batteries or how to dispose of them properly. This product contains mercury. Disposal of this material may be regulated due to environmental considerations. For disposal, reuse or recycling information, please contact your local government.
- If your hard disk or other storage media contains sensitive data, you should be aware that standard deletion procedures do not remove data from the media. These standard deletion procedures include:
 - Selecting Delete for a target file
 - Putting files in the Recycle Bin and emptying the Recycle Bin

- Reformatting the media
- Reinstalling an operating system from the recovery CD-ROM

The procedures above delete only the initial part of the data used for file management. This makes the file invisible to the operating system, but the data can still be read by specialized utilities. If you dispose of the PC, please delete all the data on its hard disk drive. Doing so prevents unauthorized use of such data. To ensure your data is not used for unauthorized purposes, you can:
- Physically destroy the hard disk drive
- Use a proven specialized utility to overwrite all data
- Take the hard disk drive to a professional deletion service

Real Time Clock

Problem	Procedure
The BIOS setting and system date/time are lost.	<p>Charge in the RTC battery is exhausted or getting low. You will need to set the date and time in the BIOS setup screen using the following procedure</p> <ol style="list-style-type: none"> 1. Press F2 key. BIOS setup will boot up. 2. Set the date in System Date. 3. Set the time in System Time. 4. Press F10 key. Confirmation message will appear. 5. Press Enter key. BIOS setup will terminate and the computer will be rebooted.



After configuring the time and date for the Real Time Clock battery, we recommend that you turn the power status of your computer to "ON" so that the Real Time Clock battery is charged.

Keyboard

Keyboard problems can be caused by your setup configuration. For more information refer to Chapter 5, [The Keyboard](#).

Problem	Procedure
Some letter keys produce numbers	Check that the numeric keypad overlay is not selected. Press Fn + F11 and try typing again.
Output to screen is garbled	<p>Make sure the software you are using is not remapping the keyboard. Remapping involves reassigning the meaning of each key. Refer to your software's documentation.</p> <p>If you are still unable to use the keyboard, consult your dealer.</p>

LCD panel

Apparent LCD problems may be related to the computer's setup.

Problem	Procedure
No display	Press hot keys Fn + F5 to change the display priority, to make sure it is not set for an external monitor.
Problems above remain unresolved or other problems occur	<p>Refer to your software's documentation to determine if the software is causing the difficulty.</p> <hr/> <p>Run the diagnostic test.</p> <hr/> <p>Contact your dealer if the problems continue.</p>

Hard disk drive

Problem	Procedure
Computer does not boot from hard disk drive	There may be a problem with your operating system files. Refer to your operating system documentation.
Slow performance	<p>Your files may be fragmented. Run disk Defragmenter to check the condition of your files and disk. Refer to your operating system documentation or online help for information on running disk Defragmenter.</p> <hr/> <p>As a last resort, reformat the hard disk. Then, reload the operating system and other files.</p> <hr/> <p>If problems persist, contact your dealer.</p>

Recovery Discs

Problem	Procedure
<p>The following message appears when executing Recovery Disc Creator.</p> <p>"The Recovery Disc Creator can not be launched because there is no recovery partition."</p>	<p>You will see this message if you have previously chosen to remove the partition and are trying to create "Recovery Media". When there is no recovery partition, the Recovery Disc Creator cannot make Recovery Media. However, if you have already created a "Recovery Media", you can use it to restore the recovery partition.</p> <p>Simply follow the instructions in "Restoring the preinstall software from your creating Recovery Media" section in this manual. You will be directed to select "Restore Original Factory Image" from the drop-down menu. If you have not created "Recovery Media", please contact TOSHIBA support for assistance.</p>

DVD Super Multi drive (Supporting DVD±R Double Layer)

For more information, refer to Chapter 4, *Operating Basics*.

Problem	Procedure
<p>You cannot access a CD/DVD in the drive</p>	<p>Make sure the drive's drawer is securely closed. Press gently until it clicks into place.</p> <hr/> <p>Open the drawer and make sure the CD/DVD is properly seated. It should lie flat with the label facing up.</p> <hr/> <p>A foreign object in the drawer could block laser light from reading the CD/DVD. Make sure there is no obstruction. Remove any foreign object.</p> <hr/> <p>Check whether the CD/DVD is dirty. If it is, wipe it with a clean cloth dipped in water or a neutral cleaner. Refer to the <i>Media care</i> section in Chapter 4, <i>Operating Basics</i>, for details on cleaning.</p>

Problem	Procedure
Some CD/DVDs run correctly, but others do not	The software or hardware configuration may be causing a problem. Make sure the hardware configuration matches your software's needs. Check the CD/DVDs documentation.
	<p>Check the type of CD/DVD you are using. The drive supports:</p> <p>DVD-ROM: DVD-ROM, DVD-Video, DVD-R, DVD-RW, DVD+R, DVD+RW, DVD-RAM</p> <p>CD-ROM: CD-DA, CD-Text, Photo CD (single/multi-session), CD-ROM Mode 1, Mode 2, CD-ROM XA Mode 2 (Form1, Form2), Enhanced CD (CDEXTRA)</p> <p>Recordable CD: CD-R, CD-RW, DVD-R, DVD-R(DL), DVD-RW, DVD+R, DVD+R(DL), DVD+RW, DVD-RAM</p>
	Check the region code on the DVD. It must match that on the DVD Super Multi drive. Region codes are listed in the Fixed optical media drives section in Chapter 2, The Grand Tour .

Pointing device

If you are using a USB mouse, also refer to the USB section in this chapter and to your mouse documentation.

TouchPad

Problem	Procedure
On-screen pointer does not respond to Pad operation	The system might be busy. If the pointer is shaped as an hourglass, wait for it to return to its normal shape and try again to move it.
Double-tapping does not work	<p>Try changing the double-click speed setting in the mouse control utility.</p> <ol style="list-style-type: none"> To access this utility, click start, Control Panel, Printers and Other Hardware, then Mouse icon. Within the Mouse Properties window, click the Buttons tab. Set the double-click speed as required and click OK.

Problem	Procedure
<p>The mouse pointer moves too fast or too slow</p>	<p>Try changing the speed setting in the mouse control utility.</p> <ol style="list-style-type: none"> 1. To access this utility, click start, Control Panel, Printers and Other Hardware, then Mouse icon. 2. Within the Mouse Properties window, click the Pointer Options tab. 3. Set the pointer speed as required and click OK.
<p>The response of the TouchPad is too sensitive</p>	<p>Adjust the touch sensitivity.</p> <ol style="list-style-type: none"> 1. To access this utility, click start, Control Panel, Printers and Other Hardware, then Mouse icon. 2. Within the Mouse Properties window, click the Device Settings tab. 3. Click the Settings button. 4. The Properties for Synaptics Touchpad on PS/2 port screen appears. Double-click Sensitivity in the Select an item section on the left side of the screen. 5. PalmCheck and Touch Sensitivity are displayed. Click Touch Sensitivity. 6. Move the slide bar for Touch Sensitivity to make an adjustment. Click the OK button. 7. Click the OK button on the Device Setting tab.

USB mouse

Problem	Procedure
<p>On-screen pointer does not respond to mouse operation</p>	<p>The system might be busy. If the pointer is shaped as an hourglass, wait for it to resume its normal shape and try again to move it.</p> <hr/> <p>Make sure the mouse is properly connected to the USB port.</p>

Problem	Procedure
Double-clicking does not work	<p>Try changing the double-click speed setting in the mouse control utility.</p> <ol style="list-style-type: none"> 1. To access this utility, click start, Control Panel, Printers and Other Hardware, then Mouse icon. 2. Within the Mouse Properties window, click the Buttons tab. 3. Set the double-click speed as required and click OK.
The mouse pointer moves too fast or too slow	<p>Try changing the speed setting in the mouse control utility.</p> <ol style="list-style-type: none"> 1. To access this utility, click start, Control Panel, Printers and Other Hardware, then Mouse icon. 2. Within the Mouse Properties window, click the Pointer Options tab. 3. Set the pointer speed as required and click OK.
The mouse pointer moves erratically	<p>The mouse might be dirty. Refer to your mouse documentation for instructions on cleaning.</p> <p>If problems persist, contact your dealer.</p>

USB

Also refer to your USB device's documentation.

Problem	Procedure
USB device does not work	<p>Check for a firm cable connection between the USB ports on the computer and the USB device.</p> <p>Make sure the USB device drivers are properly installed. Refer to your Windows® XP documentation for information on checking the drivers.</p> <p>If problems persist, contact your dealer.</p>

Memory expansion

Refer also to Chapter 8, *Optional Devices*, for information on installing memory modules.

Problem	Procedure
The computer hangs up	<p>Make sure the memory module installed in the expansion slot is compatible with the computer. If an incompatible module has been installed, follow the steps below.</p> <ol style="list-style-type: none"> 1. Turn off the power. 2. Disconnect the AC adaptor and all peripheral devices. 3. Remove the battery pack. 4. Remove the memory module. 5. Replace the battery pack and/or connect the AC adaptor. 6. Turn on the power. <p>If problems persist, contact your dealer.</p>

Sound system

Refer also to documentation for your audio devices.

Problem	Procedure
No sound is heard	<p>Check the software volume settings.</p> <hr/> <p>Make sure the headphone connection is secure. If problems persist, contact your dealer.</p>

Monitor

Refer also to Chapter 8, *Optional Devices*, and to your monitor's documentation.

Problem	Procedure
Monitor does not turn on	<p>Make sure that the external monitor's power switch is on. Confirm that the external monitor's power cable is plugged into a working power outlet.</p>

Problem	Procedure
No display	<p>Try adjusting the contrast and brightness controls on the external monitor.</p> <hr/> <p>Press hot keys Fn + F5 to change the display priority and make sure it is not set for the internal display.</p>
Display error occurs	<p>Check that the cable connecting the external monitor to the computer is attached firmly.</p> <p>If problems persist, contact your dealer.</p>

Modem

Problem	Procedure
Communication software can't initialize modem	<p>Make sure the computer's internal modem settings are correct. Refer to Phone and Modem Properties in the Control Panel.</p>
You can hear a dial tone but can't make a call	<p>If the call is going through a PBX machine, make sure the communication application's tone dial detection feature is disabled.</p> <p>You can also use the ATX command.</p>
You place a call, but a connection can't be made	<p>Make sure the settings are correct in your communications application.</p>
After making a call you can't hear a ring	<p>Make sure the tone or pulse selection in your communications application is set correctly.</p> <p>You can also use the ATD command.</p>
Communication is cut off unexpectedly	<p>The computer will automatically cut off communication when connection with the carrier is not successful for a set time interval. Try lengthening this time interval.</p>
A CONNECT display is quickly replaced by NO CARRIER	<p>Check the error control setting in your communications application.</p> <p>You can also use the ATN command.</p>

Problem	Procedure
Character display becomes garbled during a communication	In data transmission, make sure the parity bit and stop bit settings correspond with those of the remote computer. Check the flow control and communication protocol.
You cannot receive an incoming call	Check the rings before auto answer setting in your communications application. You can also use the ATSO command. If problems persist, contact your dealer.

LAN

Problem	Procedure
Cannot access LAN	Check for a firm cable connection between the LAN jack and the LAN hub. If problems persist, consult your LAN administrator.

Wireless LAN

If the following procedures do not restore LAN access, consult your LAN administrator. For more information on wireless communication, refer to Chapter 4, *Operating Basics*.

Problem	Procedure
Cannot access Wireless LAN	Make sure the computer's wireless communication switch is set to on. If problems persist, contact your LAN administrator.



The Wireless LAN feature is not available on all models.

Fingerprint Sensor

Problem	Procedure
Reading of the fingerprint was not successful.	<p>Please try again using the correct posture. Refer to <i>Using the FingerPrint Reader (depends on model purchased)</i> in Chapter 4, <i>Operating Basics</i>.</p> <p>Try the recognition process again using another enrolled finger.</p>
The fingerprint cannot be read due to injuries to the finger.	<p>Try the recognition process again using another enrolled finger.</p> <p>If fingerprints from all the enrolled fingers cannot be read, please log-on by using the keyboard to input the password for the time being.</p> <p>If problems persist, contact your dealer.</p>
Fingerprint Power on Security or Single Sign On feature cannot be enabled.	<p>Please use TOSHIBA Password Utility to register the User Password if it was not registered.</p>
Fingerprint Power on Security does not work	<ol style="list-style-type: none"> 1. Make sure you have enroll finger in windows account. 2. Set the User Password by using TOSHIBA Password Utility and restart the system. 3. Make sure place a checkmark in Replace the power-on and hard drive passwords with the fingerprint reader on the Protector Suite QL setting.

PC/Express Card

Refer also to Chapter 8, *Optional Devices*.

Problem	Procedure
PC/Express Card error occurs	<p>Reseat the PC/Express Card to make sure it is firmly connected.</p> <p>Make sure the connection between the external device and the card is firm.</p> <p>Check the card's documentation.</p> <p>If problems persist, contact your dealer.</p>

TOSHIBA support

If you require any additional help using your computer or if you are having problems operating the computer, you may need to contact TOSHIBA for additional technical assistance.

Before you call

Some problems you experience may be related to software or the operating system, it is important to investigate other sources of assistance first. Before contacting TOSHIBA, try the following:

- Review troubleshooting sections in the documentation for software and peripheral devices.
- If a problem occurs when you are running software applications, consult the software documentation for troubleshooting suggestions. Call the software company's technical support for assistance.
- Consult the dealer you purchased your computer and/or software from. They are your best sources for current information and support.

Where to write

If you are still unable to solve the problem and suspect that it is hardware related, write to TOSHIBA at the nearest location listed on the below.

Outside of Europe	In Europe
<p>Australia TOSHIBA Australia Pty. Ltd. Information Systems Division 84-92 Talavera Road North Ryde N.S.W. 2113 Sydney</p>	<p>Germany & Austria TOSHIBA Europe (I.E.) GmbH Geschäftsbereich, Deutschland-Österreich Hammfelddamm8, D-41460 Neuss, Germany</p>
<p>Canada TOSHIBA of Canada Ltd. 191 McNabb Street, Markham, Ontario L3R 8H2</p>	<p>France TOSHIBA Systèmes France S.A. 7, Rue Ampère B.P. 131, 92804 Puteaux Cedex</p>
<p>China TOSHIBA Personal Computer & Network (Shanghai) Co. Ltd. 43F, Hongkong new world tower, No. 300 Huai Hai Zhong Road, Shanghai, P.R. China 200021</p>	<p>Netherlands TOSHIBA Information Systems, Benelux B.V. Rivium Boulevard 41 2909 LK Capelle a/d IJssel</p>

Outside of Europe	In Europe
Singapore TOSHIBA Singapore Pte. Ltd. 438B Alexandra Road #06-01 Alexandra Technopark Singapore 119968	Spain TOSHIBA Information Systems, ESPAÑA Parque Empresarial San Fernando Edificio Europa, la Planta, Escalera A 28830 Madrid
United States of America TOSHIBA America Information Systems, Inc. 9740 Irvine Boulevard Irvine, California 92618 USA	United Kingdom TOSHIBA Information Systems (U.K.) Ltd. TOSHIBA Court Weybridge Business Park Addlestone Road Weybridge, Surrey KT15 2UL
	The Rest of Europe TOSHIBA Europe (I.E.) GmbH Geschäftsbereich, Deutschland-Österreich Hammfelddamm 8, D-41460 Neuss, Germany

Appendix A

Specifications

This appendix summarizes the computer's technical specifications.

Physical Dimensions

Weight	2.1Kg * Weight may vary depending on product configuration, vendor components, manufacturing variability and options selected.
Size	310 (w) x 227 (d) x max. 34.0/min. 27.6 (h) millimetres (not including parts that extend beyond the main body)

Environmental Requirements

	Operating	Non-operating
Ambient temperature	5°C to 35°C	-20°C to 65°C
Thermal gradient	15°C per hour maximum	20°C per hour maximum
Relative humidity	20% to 80%	10% to 95%
Altitude (from sea level)	0 to 3,000 meters	-60 to 10,000 meters

Power Requirements

AC adaptor	100-240 volts AC 50 or 60 hertz (cycles per second)
Computer	19 VDC 3.42 amperes

Built-in Modem

Network control unit (NCU)	
Type of NCU	AA
Type of line	Telephone line (analog only)
Type of dialling	Pulse Tone
Control command	AT commands EIA-578 commands
Monitor function	Computer's speaker
Communication specifications	
Communication System	Data: Full duplex Fax: Half duplex
Communication protocol	Data ITU-T-Rec V.21/V.22/V.22bis/V.32/ (Former CCITT) V.32bis/V.34/V.90/V.92 Bell 103/212A Fax: ITU-T-Rec V.17/V.29/V.27ter/V.21 ch2 (Former CCITT)
Communication Speed	Data transmission and reception 300/1200/2400/4800/7200/9600/12000/14400/ 16800/19200/21600/24000/26400/28800/31200/ 33600 bps Data reception only with V.90 28000/29333/30666/32000/33333/34666/36000/ 37333/38666/40000/41333/42666/44000/45333/ 46666/48000/49333/50666/52000/53333/54666/ 56000 bps Fax 2400/4800/7200/9600/12000/14400 bps

Transmitting level	-10 dBm
Receiving level	-10 to -40 dBm
Input/output impedance	600 ohms \pm 30%
Error correcting	MNP class 4 and ITU-T V.42
Data compression	MNP class 5 and ITU-T V.42bis
Power supply	+3.3V (supplied by computer)

Appendix B

Display Controller and Modes

Display controller

The display controller interprets software commands into hardware commands that turn particular picture elements (pels) on or off.

The controller is an advanced Video Graphics Array (VGA) that provides Graphics Array (XGA) support for the internal LCD and external monitors.

The following is available:

- 13.3", 1280 horizontal × 800 vertical pixels

A high-resolution external monitor connected to the computer can display up to 2048 horizontal and 1536 vertical pixels at 16 M colors. (Depends on the model you purchased.)

The display controller also controls the video mode, which uses industry standard rules to govern the screen resolution and the maximum number of colors that can be displayed on screen.

Software written for a given video mode will run on any computer that supports the mode.

The computer's display controller supports all VGA modes, the most widely used industry standards.

This series are equipped with Mobile Intel® 965 Express display adaptors.

The video modes supported by the display chipset are shown in following tables.

Video modes

The computer supports video modes defined in the tables below. If your application offers a selection of mode numbers that do not match the numbers on the table, select a mode based on mode type, resolution, character matrix, number of colors and refresh rates. Also, if your software supports both graphics and text modes, the screen display may appear to operate faster using a text mode.



If you are running some applications (for example a 3D application or video playback and so on), you may see some disturbance, flickering or frame dropping on your screen. If that occurs, adjust the resolution of display, lowering it until the screen is displayed properly. You could also disable Windows Aero™ to help correct this situation.

Table 1: Video modes (VGA)

Video mode	Type	Resolution	Character matrix (pels)	LCD colors	CRT colors	Scanning frequency Vertical (Hz)
0, 1	VGA Text	40 x 25 Characters	8 x 8	16 of 256K	16 of 256K	70
2, 3	VGA Text	80 x 25 Characters	8 x 8	16 of 256K	16 of 256K	70
0*, 1*	VGA Text	40 x 25 Characters	8 x 14	16 of 256K	16 of 256K	70
2*, 3*	VGA Text	80 x 25 Characters	8 x 14	16 of 256K	16 of 256K	70
0+, 1+	VGA Text	40 x 25 Characters	9 x 16	16 of 256K	16 of 256K	70
2+, 3+	VGA Text	80 x 25 Characters	9 x 16	16 of 256K	16 of 256K	70
4, 5	VGA Grph	320 x 200 Pels	8 x 8	4 of 256K	4 of 256K	70
6	VGA Grph	640 x 200 Pels	8 x 8	2 of 256K	2 of 256K	70
7	VGA Text	80 x 25 Characters	9 x 14	Mono	Mono	70
7+	VGA Text	80 x 25 Characters	9 x 16	Mono	Mono	70

Table 1: Video modes (VGA) (continued)

Video mode	Type	Resolution	Character matrix (pels)	LCD colors	CRT colors	Scanning frequency Vertical (Hz)
D	VGA Grph	320 x 200 Pels	8 x 8	16 of 256K	16 of 256K	70
E	VGA Grph	640 x 200 Pels	8 x 8	16 of 256K	16 of 256K	70
F	VGA Grph	640 x 350 Pels	8 x 14	Mono	Mono	70
10	VGA Grph	640 x 350 Pels	8 x 14	16 of 256K	16 of 256K	70
11	VGA Grph	640 x 480 Pels	8 x 16	2 of 256K	2 of 256K	60
12	VGA Grph	640 x 480 Pels	8 x 16	16 of 256K	16 of 256K	60
13	VGA Grph	320 x 200 Pels	8 x 8	256 of 256K	256 of 256K	70

Table 2: Video modes

Resolution	LCD colors	CRT colors	Vertical frequency (Hz)
800 x 600	256K/256K	256K/256K	60 75 85
1024 x 768	256K/256K	256K/256K	60 75 85
1280 x 800	256K/256K	256K/256K	60 75 85
1280 x 1024		256K/256K	60 75 85
1600 x 1200		256K/256K	60 75 85
1920 x 1440		256K/256K	60 75
2048 x 1536		256K/256K	60



Some modes are not supported at LCD+CRT simultaneous mode and LCD+CRT Multi Monitor mode.



Some models only support a maximum resolution of 1024 x 768.

Table 2: Video modes (continued)

Resolution	LCD colors	CRT colors	Vertical frequency (Hz)
800 x 600	16M/16M	16M/16M	60 75 85
1024 x 768	16M/16M	16M/16M	60 75 85
1280 x 800	16M/16M	16M/16M	60 75 85
1280 x 1024		16M/16M	60 75 85
1600 x 1200		16M/16M	60 75 85
1920 x 1440		16M/16M	60 75
2048 x 1536		16M/16M	60



Some modes are not supported at LCD+CRT simultaneous mode and LCD+CRT Multi Monitor mode.



Some models only support a maximum resolution of 1024 x 768.

Display Settings

1. You cannot move from the **Settings** tab of **Display Properties** to the multi-monitor when you are using the display of the computer and an external CRT display at the same time.
 - The **Settings** tab is displayed in the following steps;
 - Open **Control Panel**, click **Appearance and Themes**
 - Click **Display**
 - Select **Settings** tab

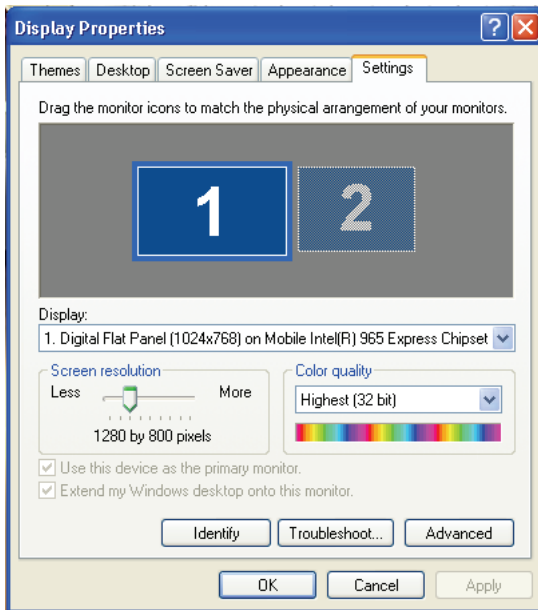

Display Properties Mobile Intel® 965 Express Graphics Controller Properties

- The way to move to multi-monitor Intel® 965 Express
 - Switch to **Display Properties**, like shown in previous page.
 - Click **Advanced in Display Properties** and choose **Intel Graphics Media Accelerator Driver for Mobile**.
 - Click the **Graphic Properties...** button.
 - Select **Display Devices** tab in **(Multiple Monitors) and Intel 965® Express Properties**.
 - With external monitor connected, choose the options under Multiple Display, then select **OK**.

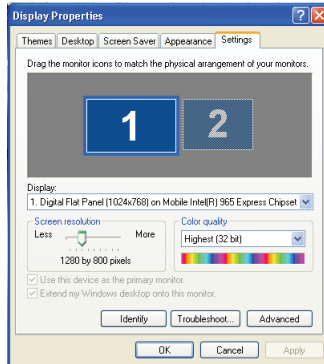

Display Properties

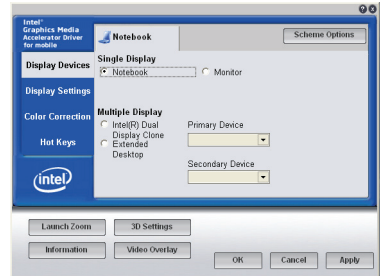

(Multiple Monitors) and Intel® 965 Express Series Properties

2. In some cases DVD video playback images may not be displayed when the display of the computer and a CRT display are used at the same. Reduce the resolution, use the display of the computer only, use the CRT display only or set display device in the multi-monitor, then play DVD.
 - Please refer to [External monitor](#) in Chapter 8, [Optional Devices](#), or the application guide for the setting of each display device.
3. The DVD video overlay is not displayed when the display mode of CRT display is set to high resolution and high refresh rate mode. Please decrease the resolution and refresh rate of CRT display.
4. When the display mode is simultaneous LCD (internal liquid crystal display) and the system goes into Standby Mode or Hibernation Mode, you can switch to the LCD (internal liquid crystal display) display mode by pressing **Fn + F5**. Under this environment, however, you may not return to the simultaneous LCD (internal liquid crystal display) display mode.

In these cases, perform the following steps:

In the Intel 965® Express Series Properties, choose the options you want to use.

Appendix C

Wireless LAN

Card Specifications

Form Factor	Mini PCI TypeIII
Compatibility	<ul style="list-style-type: none"> ■ IEEE 802.11 Standard for Wireless LANs ■ Wi-Fi (Wireless Fidelity) certified by the Wi-Fi Alliance. The "Wi-Fi CERTIFIED" logo is a certification mark of the Wi-Fi Alliance.
Network Operating System	<ul style="list-style-type: none"> ■ Microsoft® Windows® Networking
Media Access Protocol	<ul style="list-style-type: none"> ■ CSMA/CA (Collision Avoidance) with Acknowledgement (ACK)
Data Rate	<ul style="list-style-type: none"> ■ 54/48/36/24/18/12/9/6 Mb/s (IEEE 802.11g) ■ 11/5.5/2/1 Mb/s (IEEE 802.11 b)



The Wireless LAN feature is not available on all models.

Radio Characteristics

Radio Characteristics of Wireless LAN Cards may vary according to:

- Country/region where the product was purchased
- Type of product

Wireless communication is often subject to local radio regulations. Although Wireless LAN wireless networking products have been designed for operation in the license-free 2.4GHz band, local radio regulations may impose a number of limitations to the use of wireless communication equipment.



Refer to the sheet "Information to the User" for regulatory information that may apply in your country/region.

R-F Frequency	■ Band 2.4GHz (2400~2497 MHz) for 802.11a/b/g/n specifications
Modulation Technique	■ DSSS-CCK, DSSS-DQPSK, DSSS-DBPSK (IEEE 802.11b) ■ OFDM-BPSK, OFDM-QPSK, OFDM-16QAM/OFDM-16QAM (IEEE 802.11g)

The range of the wireless signal is related to the transmit rate of the wireless communication device. Communications at a lower transmission rate may travel larger distances.

- The range of your wireless devices can be affected when the antennas are placed near metal surfaces and solid high-density materials.
- Range is also impacted due to “obstacles” in the path of the transmission that may either absorb or reflect the radio signal.

Supported Frequency Sub-bands

Subject to the radio regulations that apply in the countries/regions, your Wireless LAN card may support a different set of 2.4 GHz channels. Consult your Authorized Wireless LAN or TOSHIBA Sales office for information about the radio regulations that apply in the countries/regions.

Wireless IEEE 802.11 Channels Sets (Revision B and G)

Frequency Range Channel ID	2400-2483.5 MHz
1	2412
2	2417
3	2422
4	2427
5	2432
6	2437
7	2442
8	2447
9	2452
10	2457 *1
11	2462
12	2467 *2
13	2472 *2

*1 Factory-set default channels

*2 Refer to the sheet *Approved Countries/Regions for use* for the countries/regions that in which these channels can be used.

When installing Wireless LAN cards, the channel configuration is managed as follows:

- For wireless clients that operate in a Wireless LAN Infrastructure, the Wireless LAN card will automatically start operation at the channel identified by the Wireless LAN Access Point. When roaming between different access points the station can dynamically switch to another channel if required.
- For Wireless LAN cards installed in wireless clients that operating in a peer-to-peer mode, the card will use the default channel 10.
- In a Wireless LAN Access Point, the Wireless LAN card will use the factory-set default channel (printed in **bold**), unless the LAN Administrator selected a different channel when configuring the Wireless LAN Access Point device.

Appendix D

AC Power Cord and Connectors

The power cord's AC input plug must be compatible with the various international AC power outlets and the cord must meet the standards for the country/region in which it is used. All cords must meet the following specifications:

Length:	Minimum 1.7 meters
Wire size:	Minimum 0.75 mm ²
Current rating:	Minimum 2.5 amperes
Voltage rating:	125 or 250 VAC (depending on country/region's power standards)

Certification agencies

U.S. and Canada:	UL listed and CSA certified No. 18 AWG, Type SVT or SPT-2 two conductor		
Australia:	AS		
Japan:	DENANHO		
Europe:			
Austria:	OVE	Italy:	IMQ
Belgium:	CEBEC	The Netherlands:	KEMA
Denmark:	DEMKO	Norway:	NEMKO
Finland:	SETI	Sweden:	SEMKO
France:	UTE	Switzerland:	SEV
Germany:	VDE	United Kingdom:	BSI

In Europe, power cords must be VDE type, H05VVH2-F and two conductor. For the United States and Canada, plug configuration must be a 2-15P (250 V) or 1-15P (125 V) as designated in the U.S. National Electrical code handbook and the Canadian Electrical Code Part II.

The following illustrations show the plug shapes for the U.S.A. and Canada, the United Kingdom, Australia and Europe.

USA and Canada

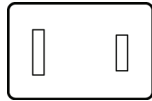

UL approved
CSA approved

United Kingdom

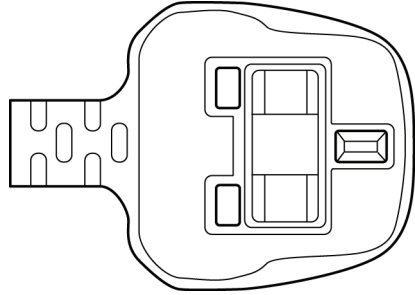

BS approved

Australia

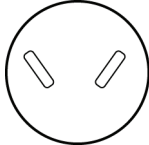

AS approved

Europe



Approved by the
appropriate agency

Appendix E

Legal Footnotes

This chapter states the Legal Footnotes information applicable to TOSHIBA computers. In the text in this manual, *XX is used to show which Legal Footnotes description is related to TOSHIBA computers.

Description(s) related to this computer are marked with a blue *XX in this manual. Clicking on *XX will display the related description.

Non-applicable Icons

Certain computer chassis are designed to accommodate all possible configurations for an entire product series. Therefore, please be aware that your selected model may not have all the features and specifications corresponding to all of the icons or switches shown on the computer chassis.

CPU

Central Processing Unit ("CPU") Performance Legal Footnotes.

CPU performance in your computer product may vary from specifications under the following conditions:

- use of certain external peripheral products
- use of battery power instead of AC power
- use of certain multimedia, computer generated graphics or video applications
- use of standard telephone lines or low speed network connections
- use of complex modeling software, such as high end computer aided design applications
- use of several applications or functionalities simultaneously
- use of computer in areas with low air pressure (high altitude >1,000 meters or >3,280 feet above sea level)

- use of computer at temperatures outside the range of 5°C to 30°C (41°F to 86°F) or >25°C (77°F) at high altitude (all temperature references are approximate and may vary depending on the specific computer model - please refer to your computer documentation or visit the TOSHIBA website at www.pcsupport.toshiba.com for details).

CPU performance may also vary from specifications due to design configuration.

Under some conditions, your computer product may automatically shutdown. This is a normal protective feature designed to reduce the risk of lost data or damage to the product when used outside recommended conditions. To avoid risk of lost data, always make back-up copies of data by periodically storing it on an external storage medium. For optimum performance, use your computer product only under recommended conditions. Read additional restrictions in your product documentation. Contact TOSHIBA technical service and support, refer to *TOSHIBA support* section in Chapter 9 *Troubleshooting* for more information.

64-Bit Computing.

64-bit processors are designed to take advantage of 32 and 64 bit computing.

64-bit computing requires that the following hardware and software requirements are met:

- 64-bit Operating System
- 64-bit CPU, Chipset and BIOS (Basic Input/Output System)
- 64-bit Device drivers
- 64-bit applications

Certain device drivers and/or applications may not be compatible with a 64-bit CPU and therefore may not function properly. A 32-bit version of the operating system is preinstalled on your computer unless explicitly stated that the operating system is 64-bit.

Memory (Main System)

Part of the main system memory may be used by the graphics system for graphics performance and therefore reduce the amount of main system memory available for other computing activities. The amount of main system memory allocated to support graphics may vary depending on the graphics system, applications utilized, system memory size and other factors. For computer's configured with 4 GB of system memory, the full system memory space for computing activities will be considerably less and will vary by model and system configuration.

Battery Life

Battery life may vary considerably depending on product model, configuration, applications, power management settings and features utilized, as well as the natural performance variations produced by the design of individual components. Published battery life numbers are achieved on select models and configurations tested by TOSHIBA at the time of publication. Recharge time varies depending on usage. Battery may not charge while computer is consuming full power.

After going through many charge and discharge cycles, the battery will lose its ability to perform at maximum capacity and will need to be replaced. This is a normal phenomenon for all batteries. To purchase a new battery pack, see the accessories information that is shipped with your computer.

Hard Disk Drive (HDD) Capacity

1 Gigabyte (GB) means $10^9 = 1,000,000,000$ bytes using powers of 10. The computer operating system, however, reports storage capacity using powers of 2 for the definition of $1 \text{ GB} = 2^{30} = 1,073,741,824$ bytes, and therefore shows less storage capacity. Available storage capacity will also be less if the product includes one or more pre-installed operating systems, such as Microsoft Windows and/or pre-installed software applications, or media content. Actual formatted capacity may vary.

LCD

Over a period of time, and depending on the usage of the computer, the brightness of the LCD screen will deteriorate. This is an intrinsic characteristic of LCD technology.

Maximum brightness is only available when operating in AC power mode. The screen will dim when the computer is operated on battery power and you may not be able to increase the brightness of the screen.

Graphics Processor Unit ("GPU")

Graphics processor unit ("GPU") performance may vary depending on product model, design configuration, applications, power management settings and features utilized. GPU performance is only optimized when operating in AC power mode and may decrease considerably when operating in battery power mode.

Wireless LAN

The transmission speed over the wireless LAN and the distance over which wireless LAN can reach may vary depending on surrounding electromagnetic environment, obstacles, access point design and configuration, and client design and software/hardware configurations.

[54Mbps is the theoretical maximum speed under the IEEE802.11 (a/b/g) standard.] The actual transmission speed will be lower than the theoretical maximum speed.

Copy Protection

Applicable copy protection standards included in certain media may prevent or limit recording or viewing of the media.

Images

All images are simulated for purposes of illustration.

Glossary

The terms in this glossary cover topics related to this manual. Alternate naming is included for reference.

Abbreviations

AC: alternating current

AGP: accelerated graphics port

ANSI: American National Standards Institute

APM: advanced power manager

ASCII: American Standard Code for Information Interchange

BIOS: basic input output system

CD-ROM: Compact Disc-Read Only Memory

CD-RW: Compact Disc-Read/Write

CMOS: complementary metal-oxide semiconductor

CPU: central processing unit

CRT: cathode ray tube

DC: direct current

DDC: display data channel

DMA: direct memory access

DOS: disk operating system

DVD: digital versatile disc

ECP: extended capabilities port

FIR: fast infrared

HDD: hard disk drive

IDE: integrated drive electronics

I/O: input/output

IrDA: Infrared Data Association

IRQ: interrupt request

KB: kilobyte

LCD: liquid crystal display

LED: light emitting diode
LSI: large scale integration
MS-DOS: Microsoft® disk Operating System
OCR: optical character recognition (reader)
PCB: printed circuit board
PCI: peripheral component interconnect
RAM: random access memory
RGB: red, green, and blue
ROM: read only memory
RTC: real time clock
SCSI: small computer system interface
SIO: serial input/output
SXGA+: super extended graphics array plus
TFT: thin-film transistor
UART: universal asynchronous receiver/transmitter
USB: Universal Serial Bus
UXGA: ultra extended graphics array
VESA: Video Electronic Standards Association
VGA: video graphics array
VRT: voltage reduction technology
XGA: extended graphics array

A

adaptor: A device that provides an interface between two dissimilar electronic devices. For example, the AC adaptor modifies the power from a wall outlet for use by the computer. This term also refers to the add-in circuit cards that control external devices, such as video monitors and magnetic tape devices.

allocate: To assign a space or function for a specific task.

alphanumeric: Keyboard characters including letters, numbers and other symbols, such as punctuation marks or mathematical symbols.

alternating current (AC): Electric current that reverses its direction of flow at regular intervals.

analog signal: A signal whose characteristics such as amplitude and frequency vary in proportion to (are an analog of) the value to be transmitted. Voice communications are analog signals.

ANSI: American National Standards Institute. An organization established to adopt and define standards for a variety of technical disciplines. For example, ANSI defined the ASCII standard and other information processing requirements.

antistatic: A material used to prevent the buildup of static electricity.

application: A group of programs that together are used for a specific task such as accounting, financial planning, spread sheets, word processing and games.

ASCII: American Standard Code for Information Interchange. ASCII code is a set of 256 binary codes that represent the most commonly used letters, numbers, and symbols.

async: Short for asynchronous.

asynchronous: Lacking regular time relationship. As applied to computer communications, asynchronous refers to the method of transmitting data that does not require a steady stream of bits to be transmitted at regular time intervals.

B

backup: A duplicate copy of files kept as a spare in case the original is destroyed.

batch file: A file that can be executed from the system prompt containing a sequence of operating system commands or executable files.

binary: The base two number system composed of zeros and ones (off or on), used by most digital computers. The right-most digit of a binary number has a value of 1, the next a value of 2, then 4, 8, 16, and so on. For example, the binary number 101 has a value of 5. *See also* ASCII.

BIOS: Basic Input Output System. The firmware that controls data flow within the computer. *See also* firmware.

bit: Derived from "binary digit," the basic unit of information used by the computer. It is either zero or one. Eight bits is one byte. *See also* byte.

board: A circuit board. An internal card containing electronic components, called chips, which perform a specific function or increase the capabilities of the system.

boot: Short for bootstrap. A program that starts or restarts the computer. The program reads instructions from a storage device into the computer's memory.

bps: Bits per second. Typically used to describe the data transmission speed of a modem.

buffer: The portion of the computer's memory where data is temporarily stored. Buffers often compensate for differences in the rate of flow from one device to another.

bus: An interface for transmission of signals, data or electric power.

byte: The representation of a single character. A sequence of eight bits treated as a single unit; also the smallest addressable unit within the system.

C

- cache memory:** High speed memory which stores data that increases processor speed and data transfer rate. When the CPU reads data from main memory, it stores a copy of this data in cache memory. The next time the CPU needs that same data, it looks for it in the cache memory rather than the main memory, which saves time. The computer has two cache levels. Level one is incorporated into the processor and level two resides in external memory.
- capacity:** The amount of data that can be stored on a magnetic storage device such as a hard disk. It is usually described in terms of kilobytes (KB), where one KB = 1024 bytes and megabytes (MB), where one MB = 1024 KB.
- card:** Synonym for board. See board.
- CardBus:** An industry standard bus for 32-bit PC Cards.
- CD-ROM:** A Compact Disc-Read Only Memory is a high capacity disc that can be read from but not written to. The CD-ROM drive uses a laser, rather than magnetic heads, to read data from the disc.
- CD-R:** A Compact Disc-Recordable disc can be written once and read many times. See also CD-ROM.
- CD-RW:** A Compact Disc-Read/Write disc can be rewritten many times. See also CD-ROM.
- character:** Any letter, number, punctuation mark, or symbol used by the computer. Also synonymous with byte.
- chassis:** The frame containing the computer.
- chip:** A small semiconductor containing computer logic and circuitry for processing, memory, input/output functions and controlling other chips.
- CMOS:** Complementary Metal-Oxide Semiconductor. An electronic circuit fabricated on a silicon wafer that requires very little power. Integrated circuits implemented in CMOS technology can be tightly packaged and are highly reliable.
- cold start:** Starting a computer that is currently off (turning on the power).
- COM1, COM2, COM3 and COM4:** The names assigned to the serial and communication ports.
- commands:** Instructions you enter at the terminal keyboard that direct the actions of the computer or its peripheral devices.
- communications:** The means by which a computer transmits and receives data to and from another computer or device. See parallel interface; serial interface.
- compatibility:** 1) The ability of one computer to accept and process data in the same manner as another computer without modifying the data or the media upon which it is being transferred.
2) the ability of one device to connect to or communicate with another system or component.
- components:** Elements or parts (of a system) which make up the whole (system).

- computer program:** A set of instructions written for a computer that enable it to achieve a desired result.
- computer system:** A combination of hardware, software, firmware, and peripheral components assembled to process data into useful information.
- configuration:** The specific components in your system (such as the terminal, printer, and disk drives) and the settings that define how your system works. You use the HW Setup program to control your system configuration.
- control keys:** A key or sequence of keys you enter from the keyboard to initiate a particular function within a program.
- controller:** Built-in hardware and software that controls the functions of a specific internal or peripheral device (e.g. keyboard controller).
- co-processor:** A circuit built into the processor that is dedicated to intensive math calculations.
- CPS:** Characters Per Second. Typically used to indicate the transmission speed of a printer.
- CPU:** Central Processing Unit. The portion of the computer that interprets and executes instructions.
- CRT:** Cathode Ray Tube. A vacuum tube in which beams projected on a fluorescent screen-producing luminous spots. An example is the television set.
- cursor:** A small, blinking rectangle or line that indicates the current position on the display screen.

D

- data:** Information that is factual, measurable or statistical that a computer can process, store, or retrieve.
- data bits:** A data communications parameter controlling the number of bits (binary digits) used to make up a byte. If data bits = 7 the computer can generate 128 unique characters. If data bits = 8 the computer can generate 256 unique characters.
- DC:** Direct Current. Electric current that flows in one direction. This type of power is usually supplied by batteries.
- default:** The parameter value automatically selected by the system when you or the program do not provide instructions. Also called a preset value.
- delete:** To remove data from a disk or other data storage device.
Synonymous with erase.
- device driver:** A program that controls communication between a specific peripheral device and the computer. The CONFIG.SYS file contains device drivers that MS-DOS loads when you turn the computer on.
- dialog box:** A window that accepts user input to make system settings or record other information.
- disk drive:** The device that randomly accesses information on a disk and copies it to the computer's memory. It also writes data from memory to the disk. To accomplish these tasks, the unit physically rotates the disk at high speed past a read-write head.

disk storage: Storing data on magnetic disk. Data is arranged on concentric tracks much like a phonograph record.

display: A CRT, LCD, or other image producing device used to view computer output.

documentation: The set of manuals and/or other instructions written for the users of a computer system or application. Computer system documentation typically includes procedural and tutorial information as well as system functions.

DOS: disk Operating System. See operating system.

driver: A software program, generally part of the operating system, that controls a specific piece of hardware (frequently a peripheral device such as a printer or mouse).

DVD-RAM: A Digital Versatile Disc Random Access Memory is a high capacity, high performance disc that lets you store large volumes of data. The DVD-ROM drive uses a laser to read data from the disc.

DVD-ROM: A Digital Versatile Disc Read Only Memory is a high capacity, high performance disc suitable for play back of video and other high-density files. The DVD-ROM drive uses a laser to read data from the disc.

E

echo: To send back a reflection of the transmitted data to the sending device. You can display the information on the screen, or output it to the printer, or both. When a computer receives back data it transmitted to a CRT (or other peripheral device) and then re-transmits the data to printer, the printer is said to echo the CRT.

erase: See delete.

escape: 1) A code (ASCII code 27), signalling the computer that what follows are commands; used with peripheral devices such as printers and modems.

2) A means of aborting the task currently in progress.

escape guard time: A time before and after an escape code is sent to the modem which distinguishes between escapes that are part of the transmitted data, and escapes that are intended as a command to the modem.

execute: To interpret and execute an instruction.

Extended Capability Port: An industry standard that provides a data buffer, switchable forward and reverse data transmission, and run length encoding (RLE) support.

F

fast infrared: An industry standard that enables cableless infrared serial data transfer at speeds of up to 4 Mbps.

file: A collection of related information; a file can contain data, programs, or both.

firmware: A set of instructions built into the hardware which controls and directs a microprocessor's activities.

Fn-esse: A TOSHIBA utility that lets you assign functions to hot keys.

- folder:** An icon in Windows® used to store documents or other folders.
- format:** The process of readying a blank disc for its first use. Formatting establishes the structure of the disc that the operating system expects before it writes files or programs onto the disc.
- function keys:** The keys labelled F1 through F12 that tell the computer to perform certain functions.

G

- gigabyte (GB):** A unit of data storage equal to 1024 megabytes. *See also* megabyte.
- graphics:** Drawings, pictures, or other images, such as charts or graphs, to present information.

H

- hard disk:** A non-removable disk usually referred to as drive C. The factory installs this disk and only a trained engineer can remove it for servicing. Also called fixed disk.
- hard disk drive (HDD):** An electromechanical device that reads and writes a hard disk. *See also* hard disk.
- hardware:** The physical electronic and mechanical components of a computer system: typically, the computer itself, external disc drives, etc. *See also* software and firmware.
- hertz:** A unit of wave frequency that equals one cycle per second.
- hexadecimal:** The base 16 numbering system composed of the digits 0 through 9 and the letters A, B, C, D, E, and F.
- host computer:** The computer that controls, regulates, and transmits information to a device or another computer.
- hot key:** The computer's feature in which certain keys in combination with the extended function key, Fn, can be used to set system parameters, such as speaker volume.
- HW Setup:** A TOSHIBA utility that lets you set the parameters for various hardware components.

I

- icon:** A small graphic image displayed on the screen or in the indicator panel. In Windows®, an icon represents an object that the user can manipulate.
- i.LINK (IEEE1394):** This port enables high-speed data transfer directly from external devices such as digital video cameras.
- input:** The data or instructions you provide to a computer, communication device or other peripheral device from the keyboard or external or internal storage devices. The data sent (or output) by the sending computer is input for the receiving computer.
- instruction:** Statements or commands that specify how to perform a particular task.

interface: 1) Hardware and/or software components of a system used specifically to connect one system or device to another.
2) To physically connect one system or device to another to exchange information.
3) The point of contact between user, the computer, and the program, for example, the keyboard or a menu.

interrupt request: A signal that gives a component access to the processor.

I/O: Input/output. Refers to acceptance and transfer of data to and from a computer.

I/O devices: Equipment used to communicate with the computer and transfer data to and from it.

IrDA 1.1: An industry standard that enables cableless infrared serial data transfer at speeds of up to 4 Mbps.

J

jumper: A small clip or wire that allows you to change the hardware characteristics by electrically connecting two points of a circuit.

K

K: Taken from the Greek word kilo, meaning 1000; often used as equivalent to 1024, or 2 raised to the 10th power. See *also* byte and kilobyte.

KB: See kilobyte.

keyboard: An input device containing switches that are activated by manually pressing marked keys. Each keystroke activates a switch that transmits a specific code to the computer. For each key, the transmitted code is, in turn, representative of the (ASCII) character marked on the key.

kilobyte (KB): A unit of data storage equal to 1024 bytes. See *also* byte and megabyte.

L

level 2 cache: See cache.

Light Emitting Diode (LED): A semiconductor device that emits light when a current is applied.

Liquid Crystal Display (LCD): Liquid crystal sealed between two sheets of glass coated with transparent conducting material. The viewing side coating is etched into character forming segments with leads that extend to the edge of the glass. Applying a voltage between the glass sheets alters the brightness of the liquid crystal.

LSI: Large Scale Integration.

- 1) A technology that allows the inclusion of up to 100,000 simple logic gates on a single chip.
- 2) An integrated circuit that uses large scale integration.

M

main board: See motherboard.

megabyte (MB): A unit of data storage equal to 1024 kilobytes. See *also* kilobyte.

megahertz: A unit of wave frequency that equals 1 million cycles per second. See *also* hertz.

menu: A software interface that displays a list of options on the screen. Also called a screen.

microprocessor: A hardware component contained in a single integrated circuit that carries out instructions. Also called the central processing unit (CPU), one of the main parts of the computer.

mode: A method of operation, for example, the boot mode, Standby Mode or the Hibernation Mode.

modem: Derived from modulator/demodulator, a device that converts (modulates) digital data for transmission over telephone lines and then converts modulated data (demodulates) to digital format where received.

monitor: A device that uses rows and columns of pixels to display alphanumeric characters or graphic images. See *also* CRT.

motherboard: A name sometimes used to refer to the main printed circuit board in processing equipment. It usually contains integrated circuits that perform the processor's basic functions and provides connectors for adding other boards that perform special functions. Sometimes called a main board.

MP3: An audio compression standard that enables high-quality transmission and real-time playback of sound files.

N

nonvolatile memory: Memory, usually read-only (ROM), that is capable of permanently storing information. Turning the computer's power off does not alter data stored in nonvolatile memory.

numeric keypad overlay: A feature that allows you to use certain keys on the keyboard to perform numeric entry, or to control cursor and page movement.

O

OCR: Optical Character Recognition (reader). A technique or device that uses laser or visible light to identify characters and input them into a storage device.

online state: A functional state of a peripheral device when it is ready to receive or transmit data.

operating system: A group of programs that controls the basic operation of a computer. Operating system functions include interpreting programs, creating data files, and controlling the transmission and receipt (input/output) of data to and from memory and peripheral devices.

output: The results of a computer operation. Output commonly indicates data.

1) printed on paper, 2) displayed at a terminal, 3) sent through the serial port of internal modem, or 4) stored on some magnetic media.

P

parity: 1) The symmetrical relationship between two parameter values (integers) both of which are either on or off; odd or even; 0 or 1.

2) In serial communications, an error detection bit that is added to a group of data bits making the sum of the bits even or odd. Parity can be set to none, odd, or even.

password: A unique string of characters used to identify a specific user.

The computer provides various levels of password protection such as user, supervisor and eject.

pel: The smallest area of the display that can be addressed by software.

Equal in size to a pixel or group of pixels. See pixel.

peripheral component interconnect: An industry standard 32-bit bus.

peripheral device: An I/O device that is external to the central processor and/or main memory such as a printer or a mouse.

pixel: A picture element. The smallest dot that can be made on a display or printer. Also called a pel.

plug and play: A capability with Windows[®] that enables the system to automatically recognize connections of external devices and make the necessary configurations in the computer.

port: The electrical connection through which the computer sends and receives data to and from devices or other computers.

printed circuit board (PCB): A hardware component of a processor to which integrated circuits and other components are attached. The board itself is typically flat and rectangular, and constructed of fiberglass, to form the attachment surface.

program: A set of instructions a computer can execute that enables it to achieve a desired result. See *also* application.

prompt: A message the computer provides indicating it is ready for or requires information or an action from you.

R

Radio frequency interference (RFI) shield: A metal shield enclosing the printed circuit boards of the printer or computer to prevent radio and TV interference. All computer equipment generates radio frequency signals. The FCC regulates the amount of signals a computing device can allow past its shielding. A Class A device is sufficient for office use. Class B provides a more stringent classification for home equipment use. TOSHIBA portable computers comply with Class B computing device regulations.

Random Access Memory (RAM): High speed memory within the computer circuitry that can be read or written to.

restart: Resetting a computer without turning it off (also called "warm boot" or "soft reset"). See *also* boot.

RGB: Red, green, and blue. A device that uses three input signals, each activating an electron gun for a primary additive color (red, green, and blue) or port for using such a device. *See also* CRT.

RJ11: A modular telephone jack.

RJ45: A modular LAN jack.

ROM: Read Only Memory: A nonvolatile memory chip manufactured to contain information that controls the computer's basic operation. You cannot access or change information stored in ROM.

S

SCSI: Small Computer System Interface is an industry standard interface for connection of a variety of peripheral devices.

serial communications: A communications technique that uses as few as two interconnecting wires to send bits one after another.

serial interface: Refers to a type of information exchange that transmits information sequentially, one bit at a time. Contrast: Parallel interface.

SIO: Serial Input/Output. The electronic methodology used in serial data transmission.

soft key: Key combinations that emulate keys on the IBM keyboard, change some configuration options, stop program execution, and access the numeric keypad overlay.

software: The set of programs, procedures and related documentation associated with a computer system. Specifically refers to computer programs that direct and control the computer system's activities. *See also* hardware.

stop bit: One or more bits of a byte that follow the transmitted character or group codes in asynchronous serial communications.

subpixel: Three elements, one red, one green and blue (RGB), that make up a pixel on the color LCD. The computer sets subpixels independently, each may emit a different degree of brightness. *See also* pixel.

synchronous: Having a constant time interval between successive bits, characters or events.

system disk: A disk that has been formatted with an operating system. For MS-DOS the operating system is contained in two hidden files and the COMMAND.COM file. You can boot a computer using a system disk. Also called an operating system disk.

T

terminal: A typewriter-like keyboard and CRT display screen connected to the computer for data input/output.

TFT display: A liquid crystal display (LCD) made from an array of liquid crystal cells using active-matrix technology with thin film transistor (TFT) to drive each cell.

TouchPad: A pointing device integrated into the TOSHIBA computer palm rest.

TTL: Transistor-transistor logic. A logic circuit design that uses switching transistors for gates and storage.

U

Universal Serial Bus: This serial interface lets you communicate with several devices connected in a chain to a single port on the computer.

V

VGA: Video Graphics Array is an industry standard video adaptor that lets you run any popular software.

volatile memory: Random access memory (RAM) that stores information as long as power is supplied to the computer.

W

warm start: Restarting or resetting a computer without turning it off.

window: A portion of the screen that can display its own application, document or dialog box. Often used to mean a Microsoft® Windows® window.

Index

A

- AC adaptor, 1-4
 - additional, 1-13
 - connecting, 3-3
- ASCII characters, 5-7

B

- Battery
 - charging, 6-7
 - extending battery life, 6-10
 - indicator, 6-1
 - location, 2-6
 - Monitoring capacity, 6-9
 - real time clock, 1-4, 6-4
 - safety precautions, 6-5
 - save mode, 1-9
 - types, 6-3
- Battery pack, 1-4
 - additional, 8-10
 - replacing, 6-11

C

- Cleaning the computer, 4-29

D

- Display, 1-5
 - automatic power off, 1-8
 - brightness decreases, 5-4
 - brightness increases, 5-4
 - controller, 1-5
 - opening, 3-4
- Display controller, B-1

E

- Equipment checklist, 1-1

F

- Floppy disk
 - using, 4-12
- Fn + Esc (sound mute), 5-3
- Fn + F1 (instant security), 5-3
- Fn + F2 (power save mode), 5-3
- Fn + F3 (Standby Mode), 5-3
- Fn + F4 (hibernation), 5-3
- Fn + F5 (display selection), 5-3
- Fn + F6 (Display Brightness decreases), 5-4
- Fn + F7 (Display Brightness increases), 5-4
- Fn + F8 (Wireless setting), 5-4
- Fn + F9 (Touch Pad), 5-4
- Fn Sticky key, 5-5
- Function keys, 5-2

G

- Graphics controller, 1-5

H

- Hard disk drive, 1-4
 - automatic power off, 1-8
- Hibernation, 1-9, 5-3
- HW Setup, 1-10

K

- Keyboard, 1-5, 5-1
 - emulating keys on
 - enhanced, 5-2
 - F1 ... F12 function keys, 5-2
 - hot keys, 5-3
 - typewriter keys, 5-1
 - Windows® special keys, 5-5
- Keypad overlay, 1-8, 5-6
 - numeric mode, 5-6
 - temporarily using normal keyboard (overlay on), 5-7
 - turning on the overlays, 5-6

L

- LAN, 1-7, 4-27
 - cable types, 4-27
 - connecting, 4-28
 - disconnecting, 4-28

M

- Media care, 4-21
 - CD/DVDs, 4-21
- Memory, 1-3
 - expansion, 1-13, 8-7
 - installing, 8-7
 - removing, 8-9
- Modem, 1-7, 4-22
 - connecting, 4-23
 - disconnecting, 4-24
 - properties menu, 4-22
 - region selection, 4-22
- Monitor, external, 1-6, 8-11

P

- PC card, 8-2
 - inserting, 8-2
 - removing, 8-3
- Ports, 1-6
 - external monitor, 1-6
 - USB, 1-6

Power

- conditions, 6-1
 - indicator, 6-2
 - panel power on/off, 1-9, 6-13
 - shut Down mode (Boot mode), 3-6
 - Standby Mode, 3-6, 3-8
 - system Auto Off, 6-13
 - turning off, 3-6
 - turning on, 3-5
- Power-up modes, 6-13
- Problems
- AC power, 9-5
 - analyzing, 9-2
 - Battery, 9-5
 - DVD Super Multi drive, 9-9
 - Hard disk drive, 9-8
 - Hardware and system checklist, 9-3
 - Keyboard, 9-7
 - LAN, 9-15
 - LCD panel, 9-8
 - Memory expansion, 9-13
 - Modem, 9-14
 - Monitor, 9-13
 - overheating power down, 9-4
 - PC card, 9-16
 - Pointing device, 9-10
 - Power, 9-4
 - Real Time Clock, 9-7
 - Self test, 9-4
 - Sound system, 9-13
 - Support from TOSHIBA, 9-17
 - System start-up, 9-3
 - USB, 9-12
 - Wireless LAN, 9-15
- Processor, 1-3
- R**
- Restarting the computer, 3-9

S

- Security lock
 - attaching, 8-11
- Soft keys
 - emulating keys on
 - enhanced keyboard, 5-2
 - ScrLock, 5-3
- Sound System, 1-6
 - headphone jack, 1-7
 - microphone jack, 1-7
 - mute hot keys, 5-3
- Standby
 - setting, 3-8
- Standby Mode, 1-9
 - setting, 3-6
 - System automatic, 1-8

T

- TOSHIBA ConfigFree, 1-12
- TOSHIBA Disc Creator, 1-12
- Touch Pad, 1-6
 - location, 2-7
 - using, 4-1

U

- USB, 1-6

V

- Video modes, B-2
- Video RAM, 1-3

W

- Wireless communication switch, 4-27
 - indicator, 4-27
- Wireless LAN, 1-7
 - using, 4-25

